



Product Change Notification / SYST-19ZDIC579

Date:

20-Apr-2022

Product Category:

EL Backlight Driver ICs

PCN Type:

Document Change

Notification Subject:

Data Sheet - MIC4832 - Low-Noise 220VPP EL Driver Revision

Affected CPNs:

[SYST-19ZDIC579_Affected_CPN_04202022.pdf](#)

[SYST-19ZDIC579_Affected_CPN_04202022.csv](#)

Notification Text:

SYST-19ZDIC579

Microchip has released a new Product Documents for the MIC4832 - Low-Noise 220VPP EL Driver of devices. If you are using one of these devices please read the document located at [MIC4832 - Low-Noise 220VPP EL Driver](#).

Notification Status: Final

Description of Change: Corrected package marking drawing in Section 7.1, Package Marking Information and added note to legend.

Impacts to Data Sheet: See above details.

Reason for Change: To Improve Productivity

Change Implementation Status: Complete

Date Document Changes Effective: 20 April 2022

NOTE: Please be advised that this is a change to the document only the product has not been changed.

Markings to Distinguish Revised from Unrevised Devices: N/A

Attachments:

[MIC4832 - Low-Noise 220VPP EL Driver](#)

Please contact your local [Microchip sales office](#) with questions or concerns regarding this notification.

Terms and Conditions:

If you wish to receive Microchip PCNs via email please register for our PCN email service at our [PCN home page](#) select register then fill in the required fields. You will find instructions about registering for Microchips PCN email service in the [PCN FAQ](#) section.

If you wish to change your PCN profile, including opt out, please go to the [PCN home page](#) select login and sign into your myMicrochip account. Select a profile option from the left navigation bar and make the applicable selections.

Affected Catalog Part Numbers (CPN)

MIC4832YMM

MIC4832YMM-TR

MIC4832YML-TR

Low-Noise 220V_{PP} EL Driver

Features

- 1.8V to 5.5V DC Input Voltage
- 220V_{PP} Output Voltage Capable
- Low Audible Noise EL Drive Waveform
- Supports EL Panel Sizes up to 3 in² (19 cm²)
- Low 45 μ A Operating Supply Current
- Small Inductor Size with Low Profile (220 μ H)
- Tiny 8-Lead 3 mm x 3 mm DFN Package
- Adjustable Boost Converter Frequency
- Adjustable EL Lamp Frequency
- 10 nA Shutdown Current

Applications

- LCD Panel Backlight
- Mobile Phones
- PDAs
- Pagers
- Calculators
- Multimedia Players
- Remote Controls
- GPS Receivers

General Description

The MIC4832 is a low-noise 220V_{PP} electroluminescent lamp (EL) driver. Using advanced Bipolar, CMOS, and DMOS (BCD) technology, the MIC4832 integrates a high voltage boost converter and an H-bridge driver for driving a large EL lamp.

The MIC4832 can drive large-panel displays for mobile phones, multimedia players, or automotive electronics where EL panels are used for backlighting.

The MIC4832 also offers design flexibility with adjustable lamp and boost converter frequencies, simply by applying external resistors. A new H-bridge design reduces audible noise by creating smoother AC voltage across the EL panel.

The MIC4832 is offered in a 3 mm x 3 mm DFN and MSOP-8 lead-free and RoHS-compliant packaging with a -40°C to 85°C junction temperature range.

Package Types

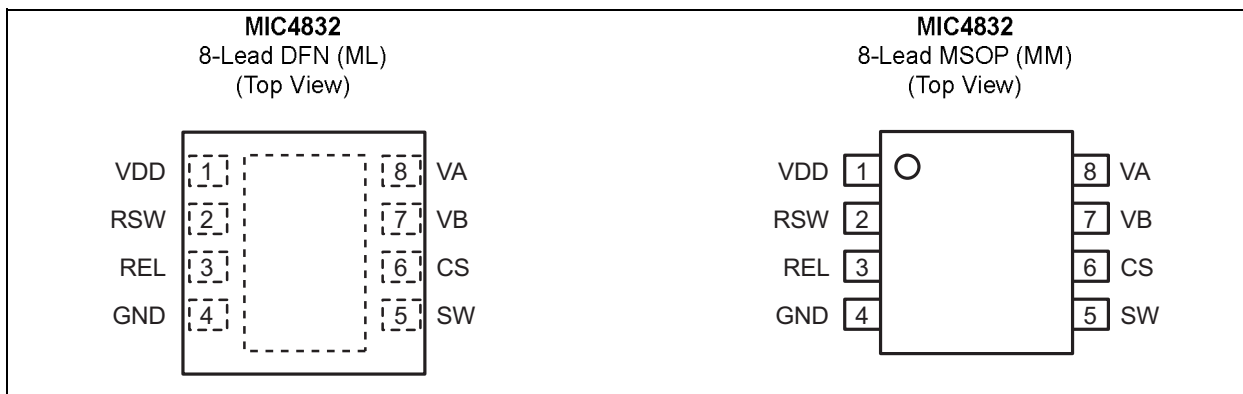

MIC4832

Typical Application Circuit

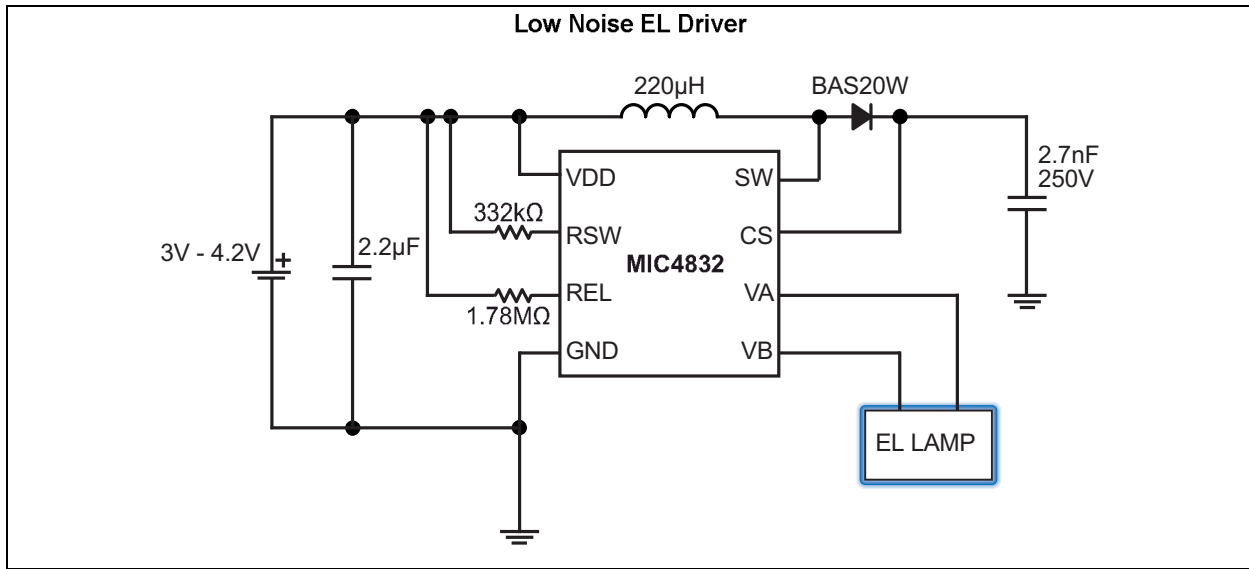

Functional Block Diagram

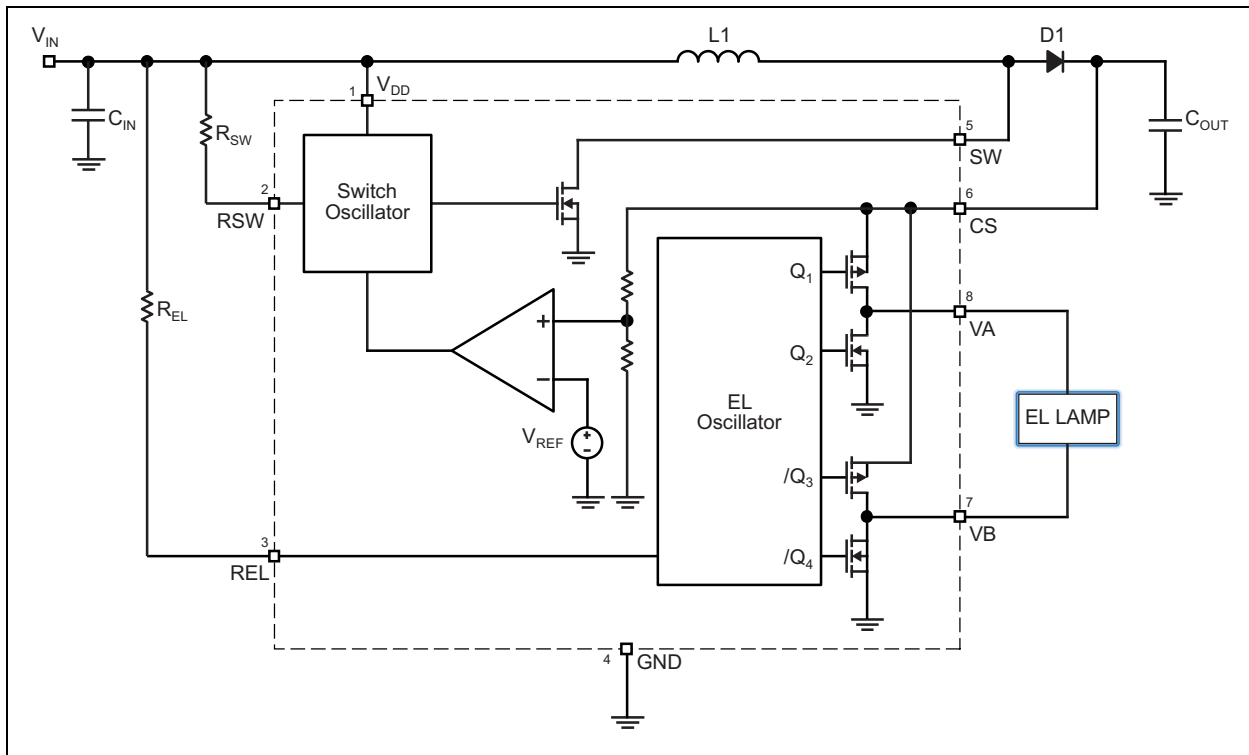

1.0 ELECTRICAL CHARACTERISTICS

Absolute Maximum Ratings †

Supply Voltage (V_{DD})	-0.5V to +6V
Output Voltage (V_{CS})	-0.5V to +120V
EL Lamp Terminals (V_A , V_B)	$V_{CS} + 3V$
Switch Voltage (V_{SW})	-0.5V to +120V
Frequency Control Voltage (V_{RSW} , V_{REL})	-0.5V to ($V_{DD} + 0.3V$)
ESD Rating (Note 1)	2 kV

Operating Ratings ††

Supply Voltage (V_{DD})	+1.8V to +5.5V
Lamp Drive Frequency (f_{EL})	60 Hz to 1000 Hz
Switching Frequency (f_{SW})	65 kHz to 250 kHz

† Notice: Exceeding the absolute maximum ratings may damage the device.

†† Notice: The device is not guaranteed to function outside its operating ratings.

Note 1: Devices are ESD sensitive. Handling precautions recommended. Human body model, 1.5 k Ω in series with 100 pF.

ELECTRICAL CHARACTERISTICS

Electrical Characteristics: $V_{IN} = V_{DD} = 3.0V$, $R_{SW} = 338\text{ k}\Omega$, $R_{EL} = 1.78\text{ M}\Omega$. $T_A = +25^\circ\text{C}$ unless otherwise specified. Bold values valid for $-40^\circ\text{C} \leq T_A \leq +85^\circ\text{C}$. Note 1						
Parameter	Sym.	Min.	Typ.	Max.	Units	Conditions
On-Resistance	$R_{DS(ON)}$	—	3.8	7	Ω	$I_{SW} = 100\text{ mA}$
CS Voltage Variation	V_{CS}	91	105	119	V	—
Enable Input Low Voltage (Turn-Off)	V_{EN-L}	—	—	0.5	V	$V_{DD} = 1.8V$ to $5.5V$
Enable Input High Voltage (Turn-On)	V_{EN-H}	$V_{DD} - 0.5$	—	—	V	$V_{DD} = 1.8V$ to $5.5V$
Shutdown Current	I_{SD}	—	0.01	0.5	μA	R_{SW} Resistor = Low; R_{EL} Resistor = Low; $V_{DD} = 5.5V$
Input Supply Current	I_{VDD}	—	45	75	μA	R_{SW} Resistor = High; R_{EL} Resistor = High; $V_{CS} = 110V$; V_A , $V_B = \text{OPEN}$
Input Current Including Inductor	I_{CS}	—	24	—	mA	$V_{IN} = V_{DD} = 3.2V$; $R_{SW} = 338\text{ k}\Omega$, $R_{EL} = 1.78\text{ M}\Omega$; $L = 220\text{ }\mu\text{H}$; $R_{OUT} = 10\text{ k}\Omega$; Lamp = 2 in^2
$V_A - V_B$ Output Drive Frequency	f_{EL}	158	200	242	Hz	$R_{EL} = 1.78\text{ M}\Omega$
Switching Transistor Frequency	f_{SW}	90	112	134	kHz	$R_{SW} = 338\text{ k}\Omega$
Switching Transistor Duty Cycle	D	—	90	—	%	—

Note 1: Specification for packaged product only.

MIC4832

TEMPERATURE SPECIFICATIONS

Parameters	Sym.	Min.	Typ.	Max.	Units	Conditions
Temperature Ranges						
Storage Temperature Range	T_S	-65	—	+150	°C	—
Ambient Temperature Range	T_A	-40	—	+85	°C	—
Package Thermal Resistance						
Thermal Resistance 8-Lead DFN	θ_{JA}	—	63	—	°C/W	—
Thermal Resistance MSOP-8	θ_{JA}	—	206	—	°C/W	—

Note 1: The maximum allowable power dissipation is a function of ambient temperature, the maximum allowable junction temperature and the thermal resistance from junction to air (i.e., T_A , T_J , θ_{JA}). Exceeding the maximum allowable power dissipation will cause the device operating junction temperature to exceed the maximum +125°C rating. Sustained junction temperatures above +125°C can impact the device reliability.

2.0 TYPICAL PERFORMANCE CURVES

Note: The graphs and tables provided following this note are a statistical summary based on a limited number of samples and are provided for informational purposes only. The performance characteristics listed herein are not tested or guaranteed. In some graphs or tables, the data presented may be outside the specified operating range (e.g., outside specified power supply range) and therefore outside the warranted range.

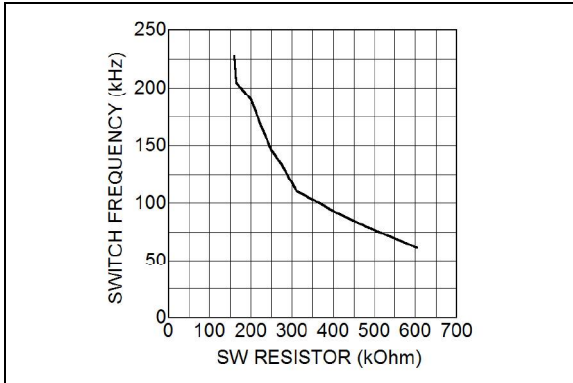

FIGURE 2-1: Switching Frequency vs. SW Resistor.

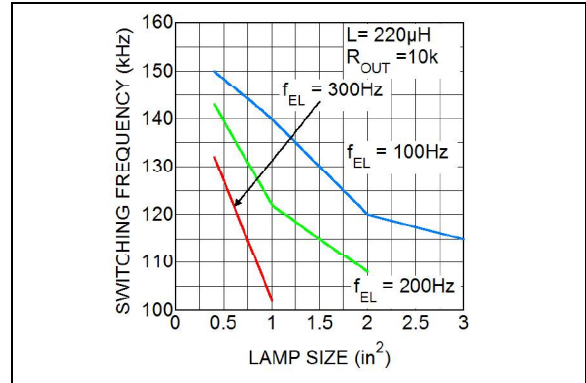

FIGURE 2-4: Switching Frequency vs. Lamp Size.

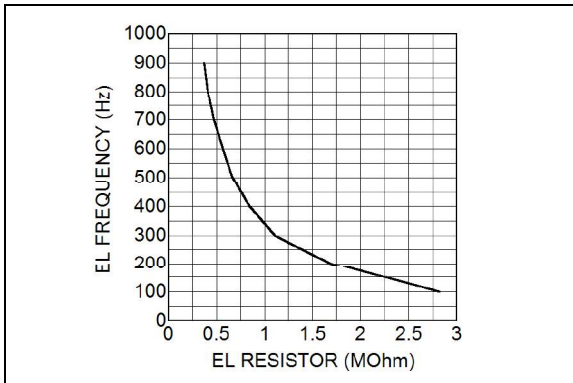

FIGURE 2-2: EL Frequency vs. EL Resistor.

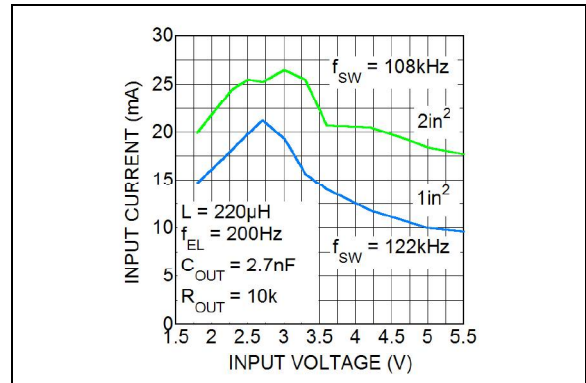

FIGURE 2-5: Total Input Current vs. Input Voltage.

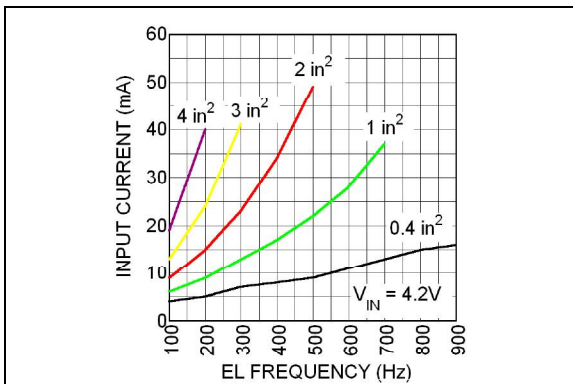

FIGURE 2-3: Input Current vs. EL Frequency.

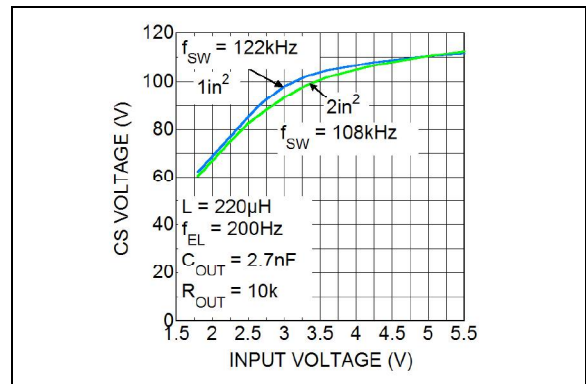

FIGURE 2-6: Peak CS Voltage vs. Input Voltage.

MIC4832

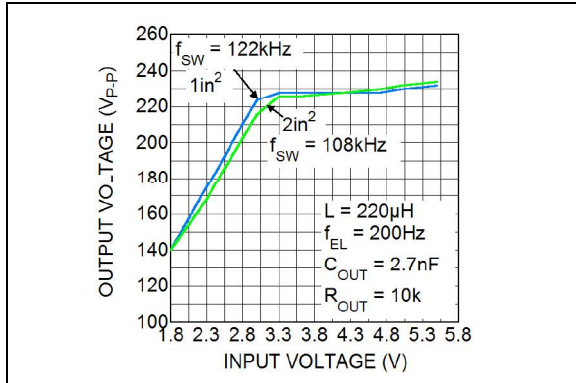

FIGURE 2-7: Peak Output Voltage vs. Input Voltage.

3.0 PIN DESCRIPTIONS

The descriptions of the pins are listed in [Table 3-1](#).

TABLE 3-1: PIN FUNCTION TABLE

Pin Number	Pin Name	Description
1	VDD	Supply (Input): 1.8V to 5.5V for internal circuitry.
2	RSW	Switch Resistor (External Component): Set switch frequency of the internal power MOSFET by connecting an external resistor to VDD. Connecting the external resistor to GND disables the switch oscillator and shuts down the device.
3	REL	EL Resistor (External Component): Set EL frequency of the internal H-Bridge driver by connecting an external resistor to VDD. Connecting the external resistor to GND disables the EL oscillator.
4	GND	Ground.
5	SW	Switch Node (Input): Internal high-voltage power MOSFET drain.
6	CS	Regulated Boost Output (External Component): Connect to the output capacitor of the boost regulator and connect to the cathode of the diode.
7	VB	EL Output: Connect to one end of the EL lamp. Polarity is not important.
8	VA	EL Output: Connect to one end of the EL lamp. Polarity is not important.

4.0 FUNCTIONAL DESCRIPTION

4.1 Overview

The MIC4832 is a high-voltage EL driver with an AC output voltage of 220V peak-to-peak that's capable of driving EL lamps up to 3 in². Input supply current for the MIC4832 is typically 45 μ A, reducing to 10 nA in shutdown. The high voltage EL driver has two internal oscillators to control the switching MOSFET and the H-Bridge driver. Both of the internal oscillators' frequencies can be individually programmed through the external resistors to maximize the efficiency and the brightness of the EL lamp.

4.2 Regulation

Referring to the [Functional Block Diagram](#), initially power is applied to V_{DD}. The internal feedback voltage is less than the reference voltage, causing the internal comparator to go high, which then enables the switching MOSFET's oscillator.

When the switching MOSFET turns on, current flows through the inductor and flows into the switch. The switching MOSFET will typically turn on for 90% of the switching period. During the on-time, energy is stored in the inductor.

When the switching MOSFET turns off, current flowing into the inductor forces the voltage across the inductor to reverse polarity. The voltage across the inductor rises until the external diode conducts and clamps the voltage at V_{OUT} + V_{D1}. The energy in the inductor is then discharged into the C_{OUT} capacitor.

The internal comparator continues to turn the switching MOSFET on and off until the internal feedback voltage is above the reference voltage. Once the internal feedback voltage is above the reference voltage, the internal comparator turns off the switching MOSFET's oscillator.

When the EL oscillator is enabled, V_A and V_B switch in opposite states to achieve a 220V peak-to-peak AC output signal. The external resistor that connects to the REL pin determines the EL frequency.

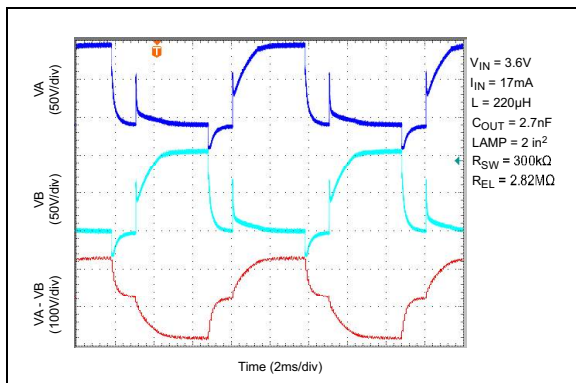

FIGURE 4-1: 100 Hz Output Waveform

4.3 Switching Frequency

The switching frequency of the converter is controlled via an external resistor between the RSW pin and VDD pin of the device. The switching frequency increases as the resistor value decreases. For resistor value selections, see [Figure 2-1](#) or use [Equation 4-1](#). The switching frequency range is 65 kHz to 250 kHz, with an accuracy of $\pm 20\%$. In general, the lower the switching frequency, the greater the input current is drawn to deliver more power to the output. However, the switching frequency should not be so low as to allow the voltage at the switch node or the CS pin to go beyond the absolute maximum voltage of those pins.

EQUATION 4-1:

$$f_{SW}(kHz) = \frac{36}{R_{SW}(M\Omega)}$$

4.4 EL Frequency

The EL lamp frequency is controlled via an external resistor connected between the REL pin and VDD pin of the device. The lamp frequency increases as the resistor value decreases. For resistor value selections, see [Figure 2-2](#) or use [Equation 4-2](#). The EL lamp frequency range is 60 Hz to 1000 Hz, with an accuracy of $\pm 20\%$.

EQUATION 4-2:

$$f_{EL}(Hz) = \frac{360}{R_{EL}(M\Omega)}$$

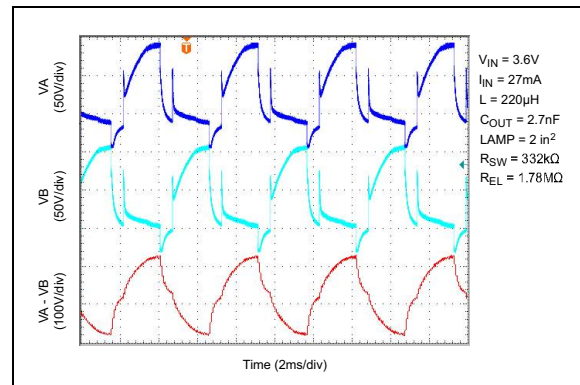

FIGURE 4-2: 200 Hz Output Waveform.

In general, as the EL lamp frequency increases, the amount of current drawn from the battery will increase. The color of the EL lamp and the intensity are dependent upon its frequency.

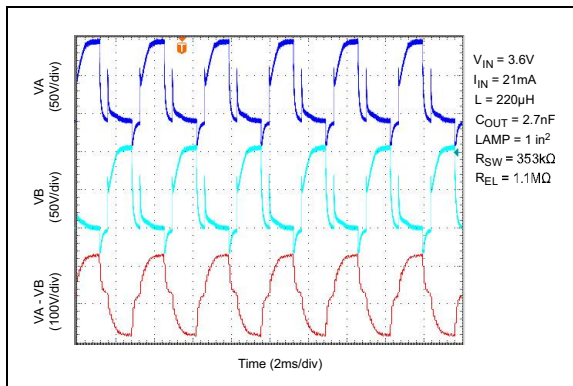

FIGURE 4-3: 300 Hz Output Waveform.

4.5 Enable Function

The MIC4832 is disabled by connecting the external resistor (R_{SW}) to GND. This turns off the switch oscillator of the boost converter. Connecting the external resistor (R_{SW}) to VDD enables the oscillator and turns on the device. The enable voltage should rise or fall monotonically without interruption.

5.0 APPLICATION INFORMATION

5.1 Inductor

A 220 μH Murata (LQH4C221K04) inductor is recommended for most applications. Generally, inductors with smaller values can handle more current. Lowering the inductance allows the boost regulator to draw more input current to deliver more energy every cycle. As a result, a lower value inductor may be used to drive larger panels or make the current panel brighter.

However, caution is required as using a low-value inductor with a low switching frequency may result in voltages exceeding the absolute maximum rating of the switch node and/or the CS pin.

If the application uses a low-input voltage (1.8V to 3V), a lower value inductor, such as 100 μH , may be used in order to drive the EL lamp at max brightness without issue.

5.2 Diode

The diode must have a high-reverse voltage (150V), because the output voltage at the CS pin can reach up to 130V. A fast-switching diode with lower forward voltage and higher reverse voltage (150V), such as BAV20WS/BAS20W, can be used to enhance efficiency.

5.3 Output Capacitor

Low-ESR capacitors should be used at the regulated boost output (CS pin) of the MIC4832 to minimize the switching output ripple voltage. The larger the output capacitance, the lower the output ripple at the CS pin. The reduced output ripple at the CS pin, along with a low-ESR capacitor, improves the efficiency of the MIC4832 circuit.

Selection of the capacitor value will depend upon the peak inductor current, inductor size, and the load. The MIC4832 is designed for use with an output capacitance as low as 2.2 nF. For minimum audible noise, the use of a COG/NPO dielectric output capacitor is recommended.

TDK and AVX offer COG/NPO dielectric capacitors in capacitances up to 2.7 nF at 200V to 250V rating in 0805 size. If output ripple is a concern, a 0.01 $\mu\text{F}/200\text{V}$ X7R output capacitor is recommended.

5.4 EL Lamp Terminals (VA, VB)

An EL lamp is connected from VA to VB as the load. The high voltage alternated across VA and VB by the H-bridge cycles generate luminance.

The voltage at VA and VB should not exceed the voltage at V_{CS} by more than 3V. This situation may become present when noisy enable signals such as those often generated by mechanical switches are applied to the driver's inputs.

To prevent overvoltage at VA and VB, 10 k Ω resistors may be placed in series from VA to the EL panel and from VB to the EL panel. An alternative to the use of 10 k Ω resistors is to apply a diode from the CS pin to VA and VB, where the cathode of the diode is on the CS side and the anode is on the VA and VB side, respectively.

6.0 APPLICATION CIRCUIT

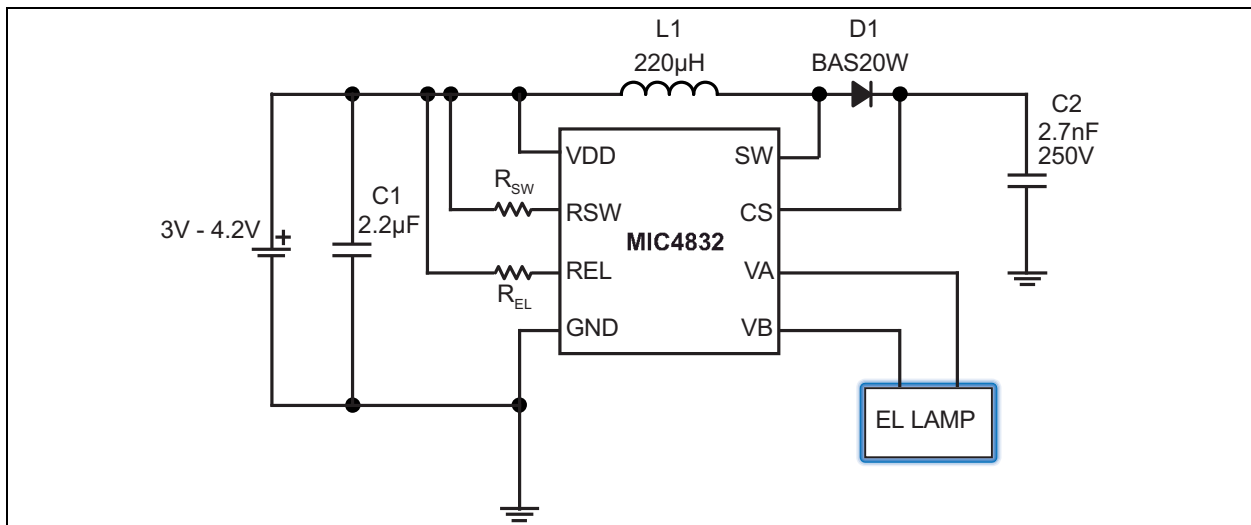

FIGURE 6-1: Typical Li-Ion Powered MIC4832 Circuit.

TABLE 6-1: RECOMMENDED R_{SW} & R_{EL} VALUES FOR VARIOUS PANEL SIZES

Size	Cap.	Lamp Freq.	100 Hz	200 Hz	300 Hz	400 Hz	500 Hz	600 Hz	700 Hz	800 Hz	900 Hz
—	—	R_{EL}	2.82 M Ω	1.69 M Ω	1.1 M Ω	0.837 M Ω	0.665 M Ω	0.562 M Ω	0.471 M Ω	0.409 M Ω	0.369 M Ω
0.4 in ²	2 nF	R_{SW}	240 k Ω	252 k Ω	273 k Ω	281 k Ω	257 k Ω	269 k Ω	281 k Ω	—	—
		f_{SW}	150 kHz	143 kHz	132 kHz	128 kHz	116 kHz	105 kHz	98 kHz	—	—
1 in ²	5 nF	R_{SW}	257 k Ω	295 k Ω	353 k Ω	—	—	—	—	—	—
		f_{SW}	140 kHz	122 kHz	102 kHz	—	—	—	—	—	—
2 in ²	10 nF	R_{SW}	300 k Ω	333 k Ω	—	—	—	—	—	—	—
		f_{SW}	120 kHz	108 kHz	—	—	—	—	—	—	—
3 in ²	15 nF	R_{SW}	313 k Ω	—	—	—	—	—	—	—	—
		f_{SW}	115 kHz	—	—	—	—	—	—	—	—

Table 6-1 applies to the circuit shown in [Figure 6-1](#).

7.0 PACKAGING INFORMATION

7.1 Package Marking Information

8-Lead MSOP*

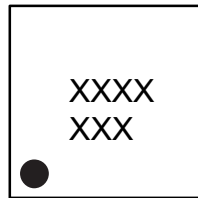

Example

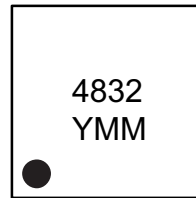

8-Lead DFN*

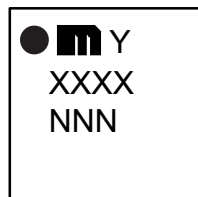

Example

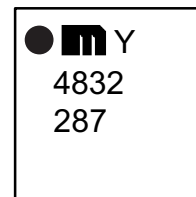

Legend:	XX...X	Product code or customer-specific information
	Y	Year code (last digit of calendar year)
	YY	Year code (last 2 digits of calendar year)
	WW	Week code (week of January 1 is week '01')
	NNN	Alphanumeric traceability code
	(e3)	Pb-free JEDEC® designator for Matte Tin (Sn)
	*	This package is Pb-free. The Pb-free JEDEC designator ((e3)) can be found on the outer packaging for this package.
	●, ▲, ▼	Pin one index is identified by a dot, delta up, or delta down (triangle mark).
Note:	In the event the full Microchip part number cannot be marked on one line, it will be carried over to the next line, thus limiting the number of available characters for customer-specific information. Package may or may not include the corporate logo.	
	Underbar () and/or Overbar () symbol may not be to scale.	

Note: If the full seven-character YYWWNNN code cannot fit on the package, the following truncated codes are used based on the available marking space:
6 Characters = YWWNNN; 5 Characters = WWNNN; 4 Characters = WNNN; 3 Characters = NNN; 2 Characters = NN; 1 Character = N

8-Lead MSOP Package Outline and Recommended Land Pattern

TITLE

8 LEAD MSOP PACKAGE OUTLINE & RECOMMENDED LAND PATTERN

DRAWING #	MSOP-8LD-PL-1	UNIT	INCH [MM]
-----------	---------------	------	-----------

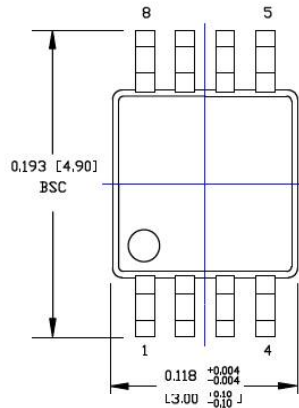

TOP VIEW

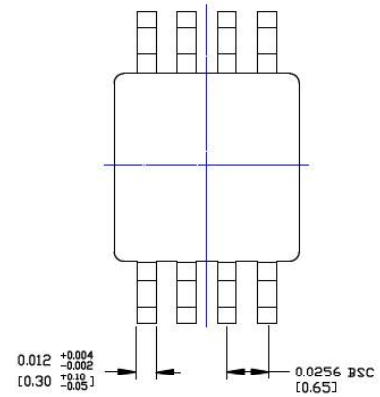

BOTTOM VIEW

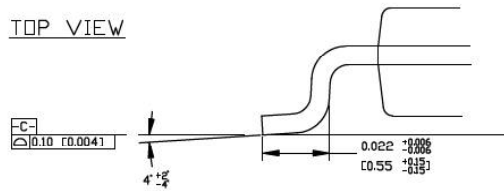

DETAIL A

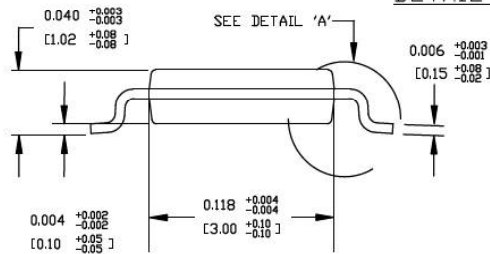

SIDE VIEW

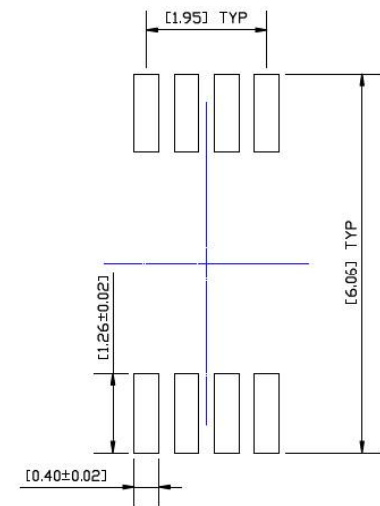

RECOMMENDED LAND PATTERN

NOTES:

1. DIMENSIONS ARE IN INCHES [MM].
2. CONTROLLING DIMENSION: MM
3. DIMENSION DOES NOT INCLUDE MOLD FLASH OR PROTRUSIONS, EITHER OF WHICH SHALL NOT EXCEED 0.008 [0.20] PER SIDE.

Note: For the most current package drawings, please see the Microchip Packaging Specification located at <http://www.microchip.com/packaging>.

MIC4832

8-Lead DFN Package Outline and Recommended Land Pattern

TITLE

8 LEAD DFN 3x3mm PACKAGE OUTLINE & RECOMMENDED LAND PATTERN

DRAWING #	DFN33-8LD-PL-1	UNIT	MM
-----------	----------------	------	----

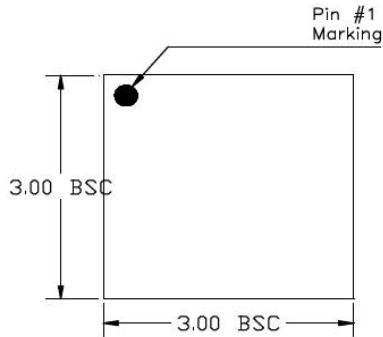

TOP VIEW

NOTE: 1, 2, 3

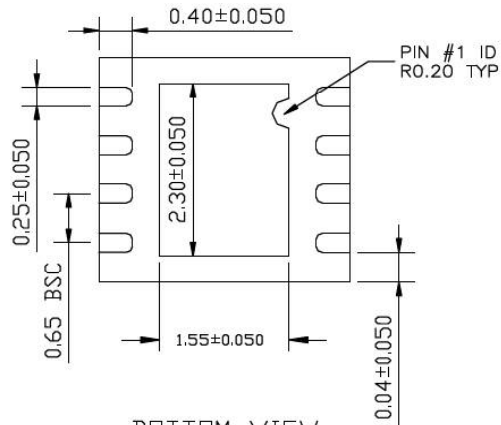

BOTTOM VIEW

NOTE: 1, 2, 3

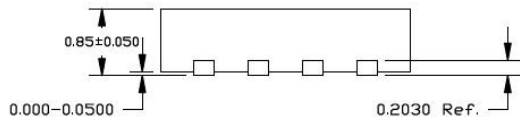

SIDE VIEW

NOTE: 1, 2, 3

NOTE:

1. MAX PACKAGE WARPAGE IS 0.05 MM
2. MAX ALLOWABLE BURR IS 0.076MM IN ALL DIRECTIONS
3. PIN #1 IS ON TOP WILL BE LASER MARKED
4. RED CIRCLE IN LAND PATTERN INDICATE THERMAL VIA. SIZE SHOULD BE 0.30-0.35 MM IN DIAMETER AND SHOULD BE CONNECTED TO GND FOR MAX THERMAL PERFORMANCE
5. GREEN RECTANGLES (SHADED AREA) INDICATE SOLDER STENCIL OPENING ON EXPOSED PAD AREA. SIZE SHOULD BE 0.50x0.90 MM IN SIZE, 0.20 MM SPACING.

Note: For the most current package drawings, please see the Microchip Packaging Specification located at <http://www.microchip.com/packaging>.

POD-Land Pattern drawing #DFN33-8LD-PL-1

RECOMMENDED LAND PATTERN

NOTE: 4, 5

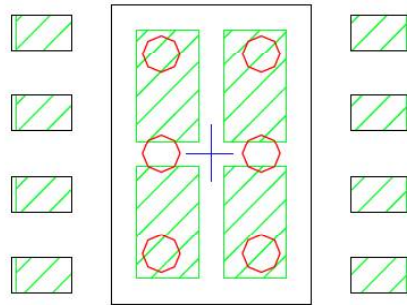

STACKED-UP

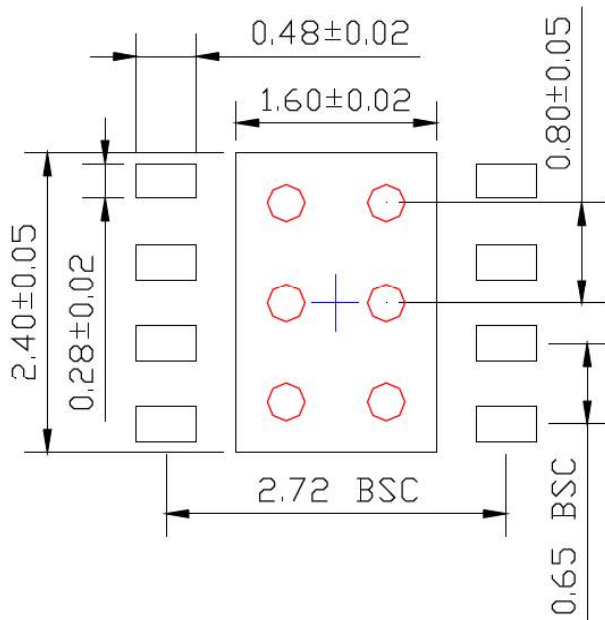

EXPOSED METAL TRACE

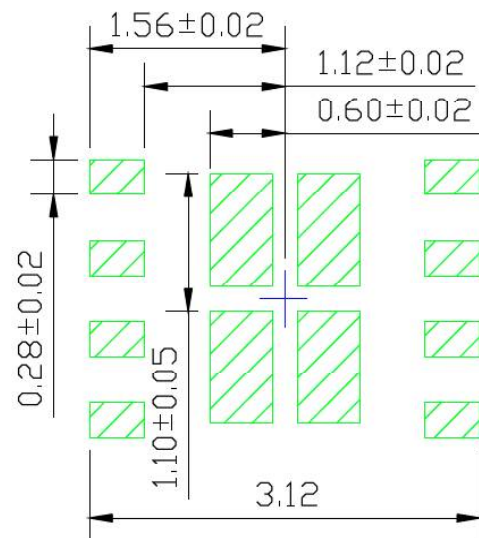

SOLDER STENCIL OPENING

Note: For the most current package drawings, please see the Microchip Packaging Specification located at <http://www.microchip.com/packaging>.

MIC4832

NOTES:

APPENDIX A: REVISION HISTORY

Revision A (March 2019)

- Converted Micrel document MIC4832 to Microchip data sheet template DS20006163A.
- Minor grammatical text changes throughout.

Revision B (February 2022)

- Corrected package marking drawing in [Section 7.1, Package Marking Information](#) and added note to legend.

MIC4832

NOTES:

PRODUCT IDENTIFICATION SYSTEM

To order or obtain information, e.g., on pricing or delivery, contact your local Microchip representative or sales office.

Device Part No.	<u>X</u> Junction Temp. Range	<u>XX</u> Package	<u>-XX</u> Media Type
Device: MIC4832:		Low Noise 220V _{PP} EL Driver	
Junction Temperature Range:	Y =	-40°C to +85°C, Industrial	
Package:	MM =	8-Lead MSOP	
	ML =	8-Lead 3 mm x 3 mm DFN	
Media Type:	<blank>=	100/Tube (MM Package)	
	TR =	2,500/Reel (MM Package)	
	TR =	5,000/Reel (ML Package)	

Examples:	
a) MIC4832YMM:	MIC4832, -40°C to +85°C Temperature Range, 8-Lead MSOP, 100/Tube
b) MIC4832YMM-TR:	MIC4832, -40°C to +85°C Temperature Range, 8-Lead MSOP, 2,500/Reel
c) MIC4832YML-TR:	MIC4832, -40°C to +85°C Temperature Range, 8-Lead 3 mm x 3 mm DFN, 5,000/Reel

Note 1: Tape and Reel identifier only appears in the catalog part number description. This identifier is used for ordering purposes and is not printed on the device package. Check with your Microchip Sales Office for package availability with the Tape and Reel option.

MIC4832

NOTES:

Note the following details of the code protection feature on Microchip products:

- Microchip products meet the specifications contained in their particular Microchip Data Sheet.
- Microchip believes that its family of products is secure when used in the intended manner, within operating specifications, and under normal conditions.
- Microchip values and aggressively protects its intellectual property rights. Attempts to breach the code protection features of Microchip product is strictly prohibited and may violate the Digital Millennium Copyright Act.
- Neither Microchip nor any other semiconductor manufacturer can guarantee the security of its code. Code protection does not mean that we are guaranteeing the product is “unbreakable”. Code protection is constantly evolving. Microchip is committed to continuously improving the code protection features of our products.

This publication and the information herein may be used only with Microchip products, including to design, test, and integrate Microchip products with your application. Use of this information in any other manner violates these terms. Information regarding device applications is provided only for your convenience and may be superseded by updates. It is your responsibility to ensure that your application meets with your specifications. Contact your local Microchip sales office for additional support or, obtain additional support at <https://www.microchip.com/en-us/support/design-help/client-support-services>.

THIS INFORMATION IS PROVIDED BY MICROCHIP "AS IS". MICROCHIP MAKES NO REPRESENTATIONS OR WARRANTIES OF ANY KIND WHETHER EXPRESS OR IMPLIED, WRITTEN OR ORAL, STATUTORY OR OTHERWISE, RELATED TO THE INFORMATION INCLUDING BUT NOT LIMITED TO ANY IMPLIED WARRANTIES OF NON-INFRINGEMENT, MERCHANTABILITY, AND FITNESS FOR A PARTICULAR PURPOSE, OR WARRANTIES RELATED TO ITS CONDITION, QUALITY, OR PERFORMANCE.

IN NO EVENT WILL MICROCHIP BE LIABLE FOR ANY INDIRECT, SPECIAL, PUNITIVE, INCIDENTAL, OR CONSEQUENTIAL LOSS, DAMAGE, COST, OR EXPENSE OF ANY KIND WHATSOEVER RELATED TO THE INFORMATION OR ITS USE, HOWEVER CAUSED, EVEN IF MICROCHIP HAS BEEN ADVISED OF THE POSSIBILITY OR THE DAMAGES ARE FORESEEABLE. TO THE FULLEST EXTENT ALLOWED BY LAW, MICROCHIP'S TOTAL LIABILITY ON ALL CLAIMS IN ANY WAY RELATED TO THE INFORMATION OR ITS USE WILL NOT EXCEED THE AMOUNT OF FEES, IF ANY, THAT YOU HAVE PAID DIRECTLY TO MICROCHIP FOR THE INFORMATION.

Use of Microchip devices in life support and/or safety applications is entirely at the buyer's risk, and the buyer agrees to defend, indemnify and hold harmless Microchip from any and all damages, claims, suits, or expenses resulting from such use. No licenses are conveyed, implicitly or otherwise, under any Microchip intellectual property rights unless otherwise stated.

For information regarding Microchip's Quality Management Systems, please visit www.microchip.com/quality.

Trademarks

The Microchip name and logo, the Microchip logo, Adaptec, AnyRate, AVR, AVR logo, AVR Freaks, BesTime, BitCloud, CryptoMemory, CryptoRF, dsPIC, flexPWR, HELDO, IGLOO, JukeBlox, KeeLoq, Klear, LANCheck, LinkMD, maXStylus, maXTouch, MediaLB, megaAVR, Microsemi, Microsemi logo, MOST, MOST logo, MPLAB, OptoLyzer, PIC, picoPower, PICSTART, PIC32 logo, PolarFire, Prochip Designer, QTouch, SAM-BA, SenGenuity, SpyNIC, SST, SST Logo, SuperFlash, Symmetricom, SyncServer, Tachyon, TimeSource, tinyAVR, UNI/O, Vectron, and XMEGA are registered trademarks of Microchip Technology Incorporated in the U.S.A. and other countries.

AgileSwitch, APT, ClockWorks, The Embedded Control Solutions Company, EtherSynch, Flashtec, Hyper Speed Control, HyperLight Load, IntelliMOS, Libero, motorBench, mTouch, Powermite 3, Precision Edge, ProASIC, ProASIC Plus, ProASIC Plus logo, QuietWire, SmartFusion, SyncWorld, Temux, TimeCesium, TimeHub, TimePictra, TimeProvider, TrueTime, WinPath, and ZL are registered trademarks of Microchip Technology Incorporated in the U.S.A.

Adjacent Key Suppression, AKS, Analog-for-the-Digital Age, Any Capacitor, AnyIn, AnyOut, Augmented Switching, BlueSky, BodyCom, CodeGuard, CryptoAuthentication, CryptoAutomotive, CryptoCompanion, CryptoController, dsPICDEM, dsPICDEM.net, Dynamic Average Matching, DAM, ECAN, Espresso T1S, EtherGREEN, GridTime, IdealBridge, In-Circuit Serial Programming, ICSP, INICnet, Intelligent Paralleling, Inter-Chip Connectivity, JitterBlocker, Knob-on-Display, maxCrypto, maxView, memBrain, Mindi, MiWi, MPASM, MPF, MPLAB Certified logo, MPLIB, MPLINK, MultiTRAK, NetDetach, NVM Express, NVMe, Omniscient Code Generation, PICDEM, PICDEM.net, PICKit, PICtail, PowerSmart, PureSilicon, QMatrix, REAL ICE, Ripple Blocker, RTAX, RTG4, SAM-ICE, Serial Quad I/O, simpleMAP, SimpliPHY, SmartBuffer, SmartHLS, SMART-I.S., storClad, SQI, SuperSwitcher, SuperSwitcher II, Switchtec, SynchroPHY, Total Endurance, TSHARC, USBCheck, VariSense, VectorBlox, VeriPHY, ViewSpan, WiperLock, XpressConnect, and ZENA are trademarks of Microchip Technology Incorporated in the U.S.A. and other countries.

SQTP is a service mark of Microchip Technology Incorporated in the U.S.A.

The Adaptec logo, Frequency on Demand, Silicon Storage Technology, Symmcom, and Trusted Time are registered trademarks of Microchip Technology Inc. in other countries.

GestIC is a registered trademark of Microchip Technology Germany II GmbH & Co. KG, a subsidiary of Microchip Technology Inc., in other countries.

All other trademarks mentioned herein are property of their respective companies.

© 2019 - 2022, Microchip Technology Incorporated and its subsidiaries.

All Rights Reserved.

ISBN: 978-1-5224-9746-2



MICROCHIP

Worldwide Sales and Service

AMERICAS

Corporate Office
2355 West Chandler Blvd.
Chandler, AZ 85224-6199
Tel: 480-792-7200
Fax: 480-792-7277
Technical Support:
<http://www.microchip.com/support>
Web Address:
www.microchip.com

Atlanta
Duluth, GA
Tel: 678-957-9614
Fax: 678-957-1455

Austin, TX
Tel: 512-257-3370

Boston
Westborough, MA
Tel: 774-760-0087
Fax: 774-760-0088

Chicago
Itasca, IL
Tel: 630-285-0071
Fax: 630-285-0075

Dallas
Addison, TX
Tel: 972-818-7423
Fax: 972-818-2924

Detroit
Novi, MI
Tel: 248-848-4000

Houston, TX
Tel: 281-894-5983

Indianapolis
Noblesville, IN
Tel: 317-773-8323
Fax: 317-773-5453
Tel: 317-536-2380

Los Angeles
Mission Viejo, CA
Tel: 949-462-9523
Fax: 949-462-9608
Tel: 951-273-7800

Raleigh, NC
Tel: 919-844-7510

New York, NY
Tel: 631-435-6000

San Jose, CA
Tel: 408-735-9110
Tel: 408-436-4270

Canada - Toronto
Tel: 905-695-1980
Fax: 905-695-2078

ASIA/PACIFIC

Australia - Sydney
Tel: 61-2-9868-6733

China - Beijing
Tel: 86-10-8569-7000

China - Chengdu
Tel: 86-28-8665-5511

China - Chongqing
Tel: 86-23-8980-9588

China - Dongguan
Tel: 86-769-8702-9880

China - Guangzhou
Tel: 86-20-8755-8029

China - Hangzhou
Tel: 86-571-8792-8115

China - Hong Kong SAR
Tel: 852-2943-5100

China - Nanjing
Tel: 86-25-8473-2460

China - Qingdao
Tel: 86-532-8502-7355

China - Shanghai
Tel: 86-21-3326-8000

China - Shenyang
Tel: 86-24-2334-2829

China - Shenzhen
Tel: 86-755-8864-2200

China - Suzhou
Tel: 86-186-6233-1526

China - Wuhan
Tel: 86-27-5980-5300

China - Xian
Tel: 86-29-8833-7252

China - Xiamen
Tel: 86-592-2388138

China - Zhuhai
Tel: 86-756-3210040

ASIA/PACIFIC

India - Bangalore
Tel: 91-80-3090-4444

India - New Delhi
Tel: 91-11-4160-8631

India - Pune
Tel: 91-20-4121-0141

Japan - Osaka
Tel: 81-6-6152-7160

Japan - Tokyo
Tel: 81-3-6880-3770

Korea - Daegu
Tel: 82-53-744-4301

Korea - Seoul
Tel: 82-2-554-7200

Malaysia - Kuala Lumpur
Tel: 60-3-7651-7906

Malaysia - Penang
Tel: 60-4-227-8870

Philippines - Manila
Tel: 63-2-634-9065

Singapore
Tel: 65-6334-8870

Taiwan - Hsin Chu
Tel: 886-3-577-8366

Taiwan - Kaohsiung
Tel: 886-7-213-7830

Taiwan - Taipei
Tel: 886-2-2508-8600

Thailand - Bangkok
Tel: 66-2-694-1351

Vietnam - Ho Chi Minh
Tel: 84-28-5448-2100

EUROPE

Austria - Wels
Tel: 43-7242-2244-39
Fax: 43-7242-2244-393

Denmark - Copenhagen
Tel: 45-4485-5910
Fax: 45-4485-2829

Finland - Espoo
Tel: 358-9-4520-820

France - Paris
Tel: 33-1-69-53-63-20
Fax: 33-1-69-30-90-79

Germany - Garching
Tel: 49-8931-9700

Germany - Haan
Tel: 49-2129-3766400

Germany - Heilbronn
Tel: 49-7131-72400

Germany - Karlsruhe
Tel: 49-721-625370

Germany - Munich
Tel: 49-89-627-144-0
Fax: 49-89-627-144-44

Germany - Rosenheim
Tel: 49-8031-354-560

Israel - Ra'anana
Tel: 972-9-744-7705

Italy - Milan
Tel: 39-0331-742611
Fax: 39-0331-466781

Italy - Padova
Tel: 39-049-7625286

Netherlands - Drunen
Tel: 31-416-690399
Fax: 31-416-690340

Norway - Trondheim
Tel: 47-7288-4388

Poland - Warsaw
Tel: 48-22-3325737

Romania - Bucharest
Tel: 40-21-407-87-50

Spain - Madrid
Tel: 34-91-708-08-90
Fax: 34-91-708-08-91

Sweden - Gothenberg
Tel: 46-31-704-60-40

Sweden - Stockholm
Tel: 46-8-5090-4654

UK - Wokingham
Tel: 44-118-921-5800
Fax: 44-118-921-5820