

Product Change Notice : PA - N Series General Power Relays

PCN.PG 03.1.10.20 21

1.10.20 21

<p>About This Notice:</p>	<p>Please be advised that the shape of the bobbin, armature and base of the PA - N Series General Power Relays will change to increase productivity .</p>
<p>Effective Date:</p>	<p>June, 2021 production onwards.</p>
<p>Change Details:</p>	<p>■ Change of parts shape</p> <div style="display: flex; align-items: center;"> <div style="border: 1px solid black; padding: 5px; margin-right: 20px;"> <p style="text-align: center; font-size: small;">Before change</p>  </div> <div style="font-size: 2em; margin-right: 20px;">➔</div> <div style="border: 1px solid black; padding: 5px;"> <p style="text-align: center; font-size: small;">After change</p>  <p style="text-align: center; font-size: x-small;">change the shape of above parts</p> </div> </div>
<p>Affected Parts:</p>	<p>All PA -N Series General Power Relays including custom products. See Attached Affected Parts list .</p>
<p>Datasheet(s):</p>	<p>See Attached.</p>
<p>Notes:</p>	<p>Part numbers, specifications and price remain unchanged. Outer carton will be marked with circled "K" for three months following the change.</p>

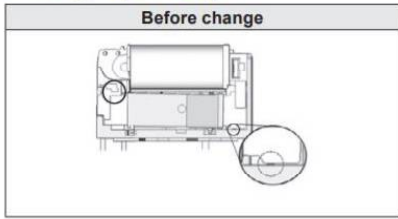
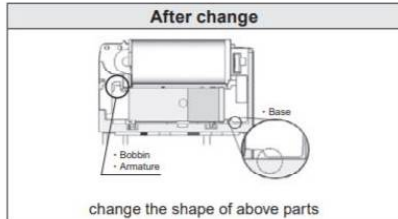

**1 Form A 5A
slim power relay
complies with IEC61010
reinforced insulation**

PA-N RELAYS



Protective construction: Sealed type (RTIII)

FEATURES

- High density mounting**
5mm(W) 20mm(L) 12.5mm(H)
- Low operating power**
Rated operating power: 110mW
- Complies with IEC61010 reinforced insulation standards**
- Long insulation distance**
 - Clearance: 5.29mm
 - Creepage distance: 5.35mm (Between contact and coil)
 - 3,000 V dielectric strength and 6,000V surge breakdown voltage
- Complies with standard for hazardous location (ANSI/ISA 12.12.01)**

TYPICAL APPLICATIONS

- Output relays for programmable controllers and temperature controllers
- Industrial equipment, office equipment
- Measuring devices and test equipment

ORDERING INFORMATION

APAN 3 1

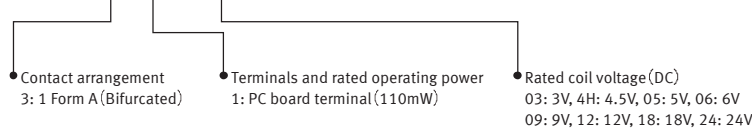

TYPES

Contact arrangement	Rated coil voltage	Part No.	Standard packing	
			Carton (Tube)	Outer carton
1 Form A	3 V DC	APAN3103	25 pieces	1,000 pieces
	4.5 V DC	APAN314H		
	5 V DC	APAN3105		
	6 V DC	APAN3106		
	9 V DC	APAN3109		
	12 V DC	APAN3112		
	18 V DC	APAN3118		
	24 V DC	APAN3124		

* Terminal sockets available.

RATING

1.Coil data

•Operating characteristics such as 'Operate voltage' and 'Release voltage' are influenced by mounting conditions, ambient temperature, etc. Therefore, please use the relay within $\pm 5\%$ of rated coil voltage.

•'Initial' means the condition of products at the time of delivery.

Rated coil voltage	Operate voltage (at 20°C)	Release voltage (at 20°C)	Rated operating current [10%] (at 20°C)	Coil resistance [$\pm 10\%$] (at 20°C)	Rated operating power	Max. allowable voltage (at 20°C)
3 V DC	70%V or less of rated voltage* (Initial)	5%V or more of rated voltage* (Initial)	36.7 mA	82 Ω	110 mW	120%V of rated voltage
4.5 V DC			24.4 mA	184 Ω		
5 V DC			22.0 mA	227 Ω		
6 V DC			18.3 mA	327 Ω		
9 V DC			12.2 mA	736 Ω		
12 V DC			9.2 mA	1,309 Ω		
18 V DC			6.1 mA	2,945 Ω		
24 V DC			4.6 mA	5,236 Ω		

Note: *Pulse drive (JIS C 5442)

2.Specifications

Item		Specifications
Contact data	Contact arrangement	1 Form A (bifurcated)
	Contact resistance (initial)	Max. 30 m Ω (by voltage drop 6 V DC 1A)
	Contact material	AgNi type + Au
	Contact rating (resistive)	5 A 250 V AC, 5 A 30 V DC
	Max. switching power (resistive)	1,250 VA, 150 W
	Max. switching voltage	250 V (AC), 110 V (DC) (0.4 A)
	Max. switching current	5 A (AC, DC)
	Min. switching capacity (reference value)* ¹	100 μ A 100 mV DC
Insulation resistance (initial)		Min. 1,000M Ω (at 500V DC) Measurement at same location as "Breakdown voltage" section.
Dielectric strength (initial)	Between open contacts	1,000 Vrms for 1min. (detection current: 10mA.)
	Between contact and coil	3,000 Vrms for 1min. (detection current: 10mA.)
Surge breakdown voltage (initial)* ²	Between contacts and coil	6,000 V
Time characteristics (initial)	Operate time	Max. 10 ms (at rated coil voltage at 20°C, without bounce)
	Release time	Max. 5 ms (at rated coil voltage at 20°C, without bounce, without diode)
Shock resistance	Functional	Min. 147 m/s ² (half-wave pulse of sine wave: 11 ms; detection time: 10 μ s.)
	Destructive	Min. 980 m/s ² (half-wave pulse of sine wave: 6 ms.)
Vibration resistance	Functional	10 to 55 Hz (at double amplitude of 2.5 mm, detection time: 10 μ s.)
	Destructive	10 to 55 Hz (at double amplitude of 3.5 mm)
Expected life	Mechanical	Min. 2 $\times 10^7$ (at 180 times/min.)
Conditions	Condition for usage, transport and storage* ³	Ambient temperature: -40°C to +90°C Humidity: 5 to 85% R.H. (not freezing and condensing at low temperature)
Unit weight		Approx. 3 g

Notes: *1. This value can change due to the switching frequency, environmental conditions, and desired reliability level, therefore it is recommended to check this with the actual load.

*2. Wave is standard shock voltage of $\pm 1.2 \times 50 \mu$ s according to JEC-212-1981

*3. The upper limit of the ambient temperature is the maximum temperature that can satisfy the coil temperature rise value. Refer to Usage, transport and storage conditions in NOTES.

3.Expected electrical life

Conditions: Resistive load, at 20 times/min.

Type	Switching capacity	Number of operations
1 Form A	3 A 250 V AC	Min. 10 ⁶
	3 A 30 V DC	Min. 10 ⁶
	5 A 250 V AC	Min. 5 $\times 10^4$ (at 6 times/min, ON:OFF = 1 s:9 s)
	5 A 30 V AC	Min. 5 $\times 10^4$

REFERENCE DATA

1. Max. switching capacity

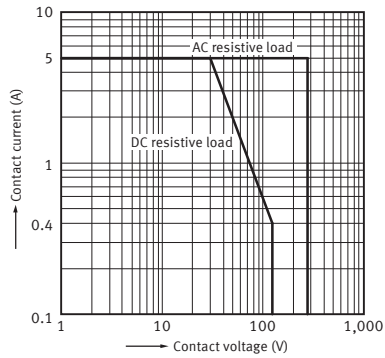

2. Life curve

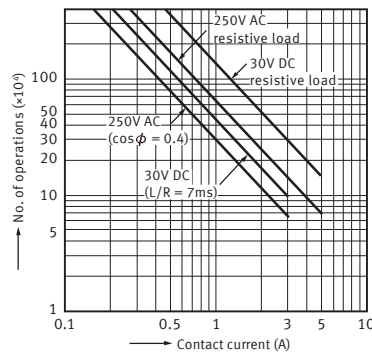

3. Coil temperature rise

Tested sample: APAN3124, 6 pcs.
Measured portion: Inside the coil
Ambient temperature: 20°C, 90°C (No contact current)

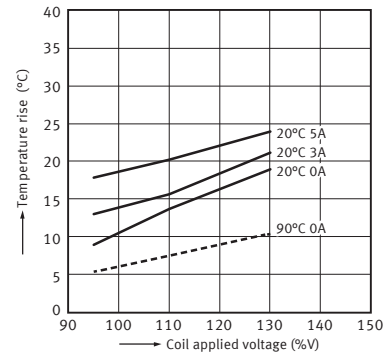

4. Ambient temperature characteristics

Tested sample: APAN3124, 6 pcs.

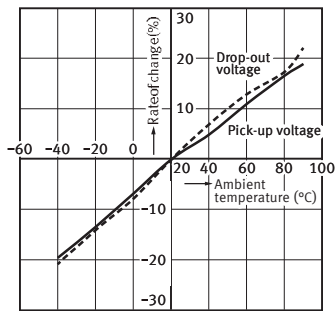

5. Operate & release time

Tested sample: APAN3124, 20 pcs.
Measured direction: Upright

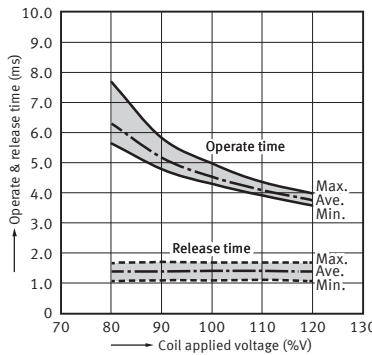

6. Malfunctional shock

Tested sample: APAN3124, 6 pcs.

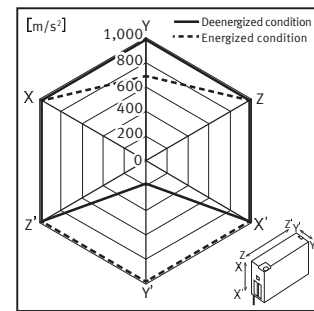

DIMENSIONS (mm)

CAD The CAD data of the products with a "CAD" mark can be downloaded from our Website.

CAD

External dimensions

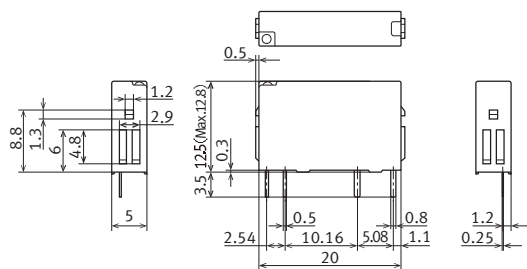

PC board pattern (Bottom view)

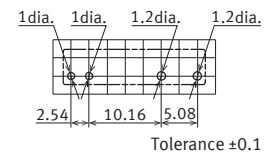

Schematic (Bottom view)

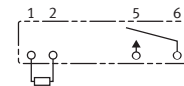

SAFETY STANDARDS

UL/C-UL (Recognized)				TÜV (Certified)			
File No.	Contact ratings	Cycles	Temp.	File No.	Contact ratings	Cycles	Temp.
E43149	5 A 250 V AC resistive	5×10 ⁴	40°C	B18 03 13461 368	5 A 250 V AC (cos φ =1.0)	5×10 ⁴	40°C
	5 A 250 V AC resistive	10 ⁴	90°C		5 A 250 V AC (cos φ =1.0)	10 ⁴	90°C
	5 A 30 V DC general use	5×10 ⁴	40°C		5 A 30 V DC (0 ms)	5×10 ⁴	40°C
	5 A 30V DC, 3 A 250 V AC general use	10 ⁴	90°C		5 A 30 V DC (0 ms)	10 ⁴	90°C
	3 A 250 V AC resistive	10 ⁵	40°C		3 A 250 V AC (cos φ =1.0)	10 ⁵	40°C
	3 A 30 V DC general use	10 ⁵	40°C		3 A 30 V DC (0 ms)	10 ⁵	40°C
E479891	Class I, division 2, groups A, B, C, D hazardous location (ANSI/ISA 12.12.01-2015, CAN/CSA C22.2 No.213-15)						

Insulation distance (between contact and coil)

• UL/C-UL: Clearance distance: 5.29 mm , Creepage distance: 5.35 mm .

• TÜV: Clearance distance: 5.29 mm , Creepage distance: 5.35 mm .

NOTES

- For cautions for use, please read “GENERAL APPLICATION GUIDELINES”.
- If it includes ripple, the ripple factor should be less than 5%.
- Specification values for pick-up and drop-out voltages are for the relay mounting with its terminals below.

Tested sample: APAN3124, 6 pcs.

Ambient temperature: 20°C

Measured direction: 6 direction

Tested sample: APAN3124, 6 pcs.

Ambient temperature: 20°C

Measured direction: 6 directions

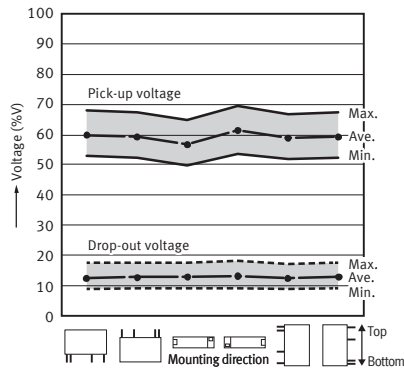

- When mounting the relays within 1 mm please notice the condition below.

1) Mount the relays in the same direction.

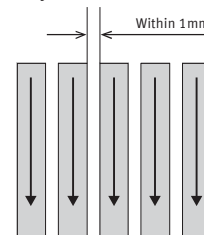

2) Coil terminals (Terminal No. 1 & 2) polarity should be arranged in the same direction.

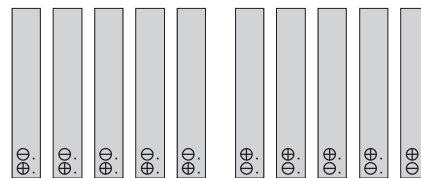

Please refer to **"the latest product specifications"** when designing your product.

•Requests to customers:

<https://industrial.panasonic.com/ac/e/salespolicies/>

ACCESSORIES

PA-N RELAYS TERMINAL SOCKETS

TYPES

Product name	Part No.
Standard type terminal socket	PA1a-PS
Self clinching type terminal socket	PA1a-PS-H

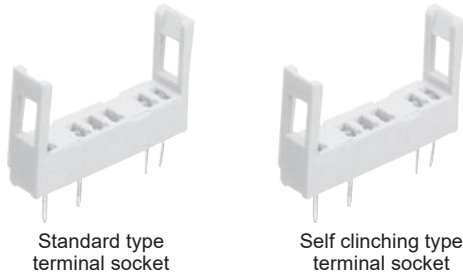

DIMENSIONS (mm inch)

CAD The CAD data of the products with a "CAD" mark can be downloaded from our Website.

Standard type terminal socket

CAD

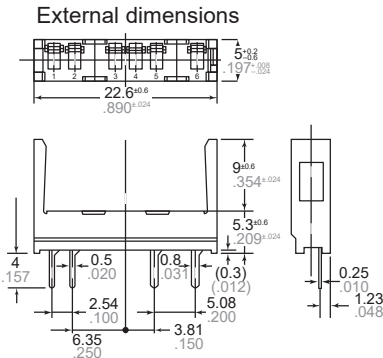

General tolerance: ±0.3 ±.012

PC board pattern (Bottom view)

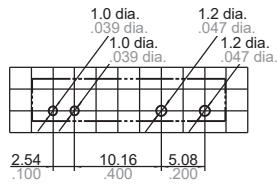

Tolerance: ±0.1 ±.004

Self clinching type terminal socket

CAD

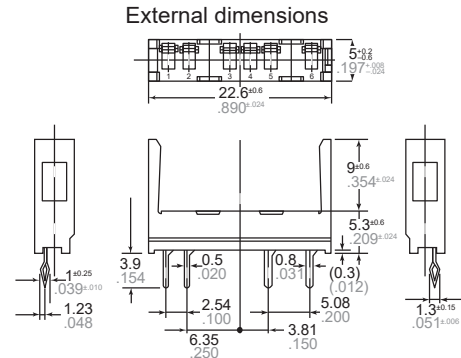

General tolerance: ±0.3 ±.012

PC board pattern (Bottom view)

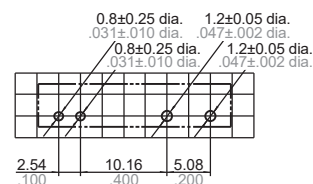

Tolerance: ±0.1 ±.004

INSTALLING AND REMOVING

Installing and removing the relay

1) Firmly insert the relay into the socket with the terminals going in the direction of the blade receptacles.

2) The relay can be easily removed using the removal key (APA801).

(1) Insert the removal key into the socket slots.

(2) Pull the removal key up to remove the relay.

(3) Slide the removal key off of the relay.

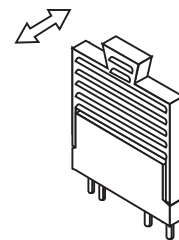
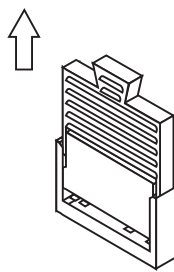
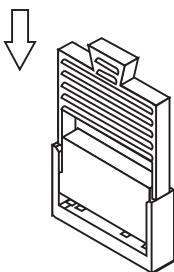

GUIDELINES FOR POWER RELAYS AND HIGH-CAPACITY DC CUT OFF RELAYS USAGE

For cautions for use, please read “GUIDELINES FOR RELAY USAGE”.

https://industrial.panasonic.com/ac/e/control/relay/cautions_use/index.jsp

Precautions for Coil Input

■ Long term current carrying

A circuit that will be carrying a current continuously for long periods without relay switching operation. (circuits for emergency lamps, alarm devices and error inspection that, for example, revert only during malfunction and output warnings with form B contacts) Continuous, long-term current to the coil will facilitate deterioration of coil insulation and characteristics due to heating of the coil itself.

For circuits such as these, please use a magnetic-hold type latching relay. If you need to use a single stable relay use a sealed type relay that is not easily affected by ambient conditions and make a failsafe circuit design that considers the possibility of contact failure or disconnection.

■ DC Coil operating power

Steady state DC current should be applied to the coil. The wave form should be rectangular. If it includes ripple, the ripple factor should be less than 5%.

However, please check with the actual circuit since the electrical characteristics may vary. The rated coil voltage should be applied to the coil and the set/reset pulse time of latching type relay differs for each relays, please refer to the relay's individual specifications.

■ Coil connection

When connecting coils of polarized relays, please check coil polarity (+, -) at the internal connection diagram (Schematic). If any wrong connection is made, it may cause unexpected malfunction, like abnormal heat, fire and so on, and circuit do not work. Avoid impressing voltages to the set coil and reset coil at the same time.

■ Maximum allowable voltage and temperature rise

Proper usage requires that the rated coil voltage be impressed on the coil. Note, however, that if a voltage greater than or equal to the maximum continuous voltage is impressed on the coil, the coil may burn or its layers short due to the temperature rise. Furthermore, do not exceed the usable ambient temperature range listed in the catalog.

■ Operate voltage change due to coil temperature rise (Hot start)

In DC relays, after continuous passage of current in the coil, if the current is turned OFF, then immediately turned ON again, due to the temperature rise in the coil, the pick-up voltage will become somewhat higher. Also, it will be the same as using it in a higher temperature atmosphere. The resistance/temperature relationship for copper wire is about 0.4% for 1°C, and with this ratio the coil resistance increases. That is, in order to operate of the relay it is necessary that the voltage be higher than the pick-up voltage and the pick-up voltage rises in accordance with the increase in the resistance value. However for some polarized relays, this rate of change is considerably smaller

Ambient Environment

● Usage, Transport, and Storage Conditions

During usage, storage, or transportation, avoid locations subjected to direct sunlight and maintain normal temperature, humidity and pressure conditions.

● Temperature/Humidity/Pressure

When transporting or storing relays while they are tube packaged, there are cases the temperature may differ from the allowable range. In this case be sure to check the individual specifications. Also allowable humidity level is influenced by temperature, please check charts shown below and use relays within mentioned conditions. (Allowable temperature values differ for each relays, please refer to the relay's individual specifications.)

1) Temperature:

The tolerance temperature range differs for each relays, please refer to the relay's individual specifications

2) Humidity:

5 to 85 % RH

3) Pressure:

86 to 106 kPa

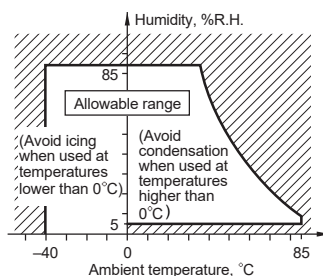

● Dew condensation

Condensation occurs when the ambient temperature drops suddenly from a high temperature and humidity, or the relay is suddenly transferred from a low ambient temperature to a high temperature and humidity. Condensation causes the failures like insulation deterioration, wire disconnection and rust etc.

Panasonic Corporation does not guarantee the failures caused by condensation.

The heat conduction by the equipment may accelerate the cooling of device itself, and the condensation may occur.

Please conduct product evaluations in the worst condition of the actual usage. (Special attention should be paid when high temperature heating parts are close to the device. Also please consider the condensation may occur inside of the device.)

● Icing

Condensation or other moisture may freeze on relays when the temperature become lower than 0°C. This icing causes the sticking of movable portion, the operation delay and the contact conduction failure etc. Panasonic Corporation does not guarantee the failures caused by the icing.

The heat conduction by the equipment may accelerate the cooling of relay itself and the icing may occur. Please conduct product evaluations in the worst condition of the actual usage.

● Low temperature and low humidity

The plastic becomes brittle if the switch is exposed to a low temperature, low humidity environment for long periods of time.

● High temperature and high humidity

Storage for extended periods of time (including transportation periods) at high temperature or high humidity levels or in atmospheres with organic gases or sulfide gases may cause a sulfide film or oxide film to form on the surfaces of the contacts and/or it may interfere with the functions. Check out the atmosphere in which the units are to be stored and transported.

●Package

In terms of the packing format used, make every effort to keep the effects of moisture, organic gases and sulfide gases to the absolute minimum.

●Silicon

When a source of silicone substances (silicone rubber, silicone oil, silicone coating materials and silicone filling materials etc.) is used around the relay, the silicone gas (low molecular siloxane etc.) may be produced.

This silicone gas may penetrate into the inside of the relay. When the relay is kept and used in this condition, silicone compound may adhere to the relay contacts which may cause the contact failure. Do not use any sources of silicone gas around the relay (including plastic seal types).

●NOx Generation

When relay is used in an atmosphere high in humidity to switch a load which easily produces an arc, the NOx created by the arc and the water absorbed from outside the relay combine to produce nitric acid. This corrodes the internal metal parts and adversely affects operation. Avoid use at an ambient humidity of 85%RH or higher (at 20°C). If use at high humidity is unavoidable, please contact our sales representative.

Others

■Cleaning

1) Although the environmentally sealed type relay (plastic sealed type, etc.) can be cleaned, avoid immersing the relay into cold liquid (such as cleaning solvent) immediately after soldering. Doing so may deteriorate the sealing performance.

2) Cleaning with the boiling method is recommended (The temperature of cleaning liquid should be 40°C or lower).

Avoid ultrasonic cleaning on relays. Use of ultrasonic cleaning may cause breaks in the coil or slight sticking of the contacts due to ultrasonic energy.

Please refer to "**the latest product specifications**" when designing your product.

•Requests to customers:

<https://industrial.panasonic.com/ac/e/salespolicies/>

Please contact

Panasonic Corporation

Electromechanical Control Business Division

■1006, Oaza kadoma, kadoma-shi, Osaka 571-8506, japan
industrial.panasonic.com/ac/e/

Panasonic®

Panasonic PCN.PG03.1.10.2021 Affected Parts

APAN3103
APAN314H
APAN3105
APAN31051
APAN3106
APAN3109
APAN3112
APAN3118
APAN3124