



Product Change Notification / SYST-12JWIG924

Date:

13-Nov-2020

Product Category:

Temperature Sensors

PCN Type:

Document Change

Notification Subject:

Data Sheet - MIC280 - Precision IttyBitty Thermal Supervisor

Affected CPNs:

[SYST-12JWIG924_Affected_CPN_11132020.pdf](#)

[SYST-12JWIG924_Affected_CPN_11132020.csv](#)

Notification Text:

SYST-12JWIG924

Microchip has released a new Product Documents for the MIC280 - Precision IttyBitty Thermal Supervisor of devices. If you are using one of these devices please read the document located at [MIC280 - Precision IttyBitty Thermal Supervisor](#) .

Notification Status: Final

Description of Change: 1) Converted Micrel data sheet MIC280 to Microchip data sheet DS20006458A. 2) Minor grammatical corrections throughout.

Impacts to Data Sheet: None

Reason for Change: Conversion of Micrel datasheet to Microchip datasheet conventions.

Change Implementation Status: Complete

Date Document Changes Effective: 13 Nov 2020

NOTE: Please be advised that this is a change to the document only the product has not been changed.

Markings to Distinguish Revised from Unrevised Devices: N/A

Attachments:

[MIC280 - Precision IttyBitty Thermal Supervisor](#)

Please contact your local [Microchip sales office](#) with questions or concerns regarding this notification.

Terms and Conditions:

If you wish to receive Microchip PCNs via email please register for our PCN email service at our [PCN home page](#) select register then fill in the required fields. You will find instructions about registering for Microchips PCN email service in the [PCN FAQ](#) section.

If you wish to change your PCN profile, including opt out, please go to the [PCN home page](#) select login and sign into your myMicrochip account. Select a profile option from the left navigation bar and make the applicable selections.

Affected Catalog Part Numbers (CPN)

MIC280-0YM6-TR

MIC280-0YM6-TX

MIC280-1YM6-TR

MIC280-1YM6-TX

MIC280-2YM6-TR

MIC280-3YM6-TR

MIC280-4YM6-TR

MIC280-5YM6-TR

MIC280-6YM6-TR

MIC280-7YM6-TR

Precision IttyBitty Thermal Supervisor

Features

- Measures Local and Remote Temperature
- Highly Accurate Remote Sensing: $\pm 1^{\circ}\text{C}$ max., $+60^{\circ}\text{C}$ to $+100^{\circ}\text{C}$
- Superior Noise Immunity for Reduced Temperature Guardbands
- 9-bit to 12-bit Temperature Resolution for Remote Zone
- Fault Queues to Further Reduce Nuisance Tripping
- Programmable High, Low, and Overtemperature Thresholds for Each Zone
- SMBus 2.0-Compatible Serial Interface Including Device Timeout to Prevent Bus Lockup
- Voltage-Tolerant I/Os
- Open-Drain Interrupt Output Pin Supports SMBus Alert Response Address Protocol
- Low Power Shutdown Mode
- Locking of Critical Functions to Ensure Failsafe Operation
- Failsafe Response to Diode Faults
- Enables ACPI-Compliant Thermal Management
- 3.0V to 3.6V Power Supply Range
- Available in IttyBitty SOT23-6 Package

Applications

- Desktop, Server, and Notebook Computers
- Printers and Copiers
- Test and Measurement Equipment
- Thermal Supervision of Xilinx Virtex FPGAs
- Wireless/RF Systems
- Intelligent Power Supplies
- Datacom/Telecom Cards

General Description

The MIC280 is a digital thermal supervisor capable of measuring its own internal temperature and that of a remote PN junction. The remote junction may be an inexpensive commodity transistor (e.g., 2N3906) or an embedded thermal diode such as those found in Intel Pentium® II/III/IV CPUs, AMD Athlon® CPUs, and Xilinx Virtex® FPGAs. A 2-wire SMBus® 2.0-compatible serial interface is provided for host communication. Remote temperature is measured with $\pm 1^{\circ}\text{C}$ accuracy and 9-bit to 12-bit resolution (programmable). Independent high, low, and overtemperature thresholds are provided for each zone.

The advanced integrating A/D converter and analog front-end reduce errors due to noise for maximum accuracy and minimum guardbanding. The interrupt output signals temperature events to the host, including data-ready and diode faults. Critical device settings can be locked to prevent changes and ensure failsafe operation. The clock, data, and interrupt pins are 5V-tolerant regardless of the value of V_{DD} . They will not clamp the bus lines low even if the device is powered down. Superior accuracy, failsafe operation, and small size make the MIC280 an excellent choice for the most demanding thermal management applications.

Package Type

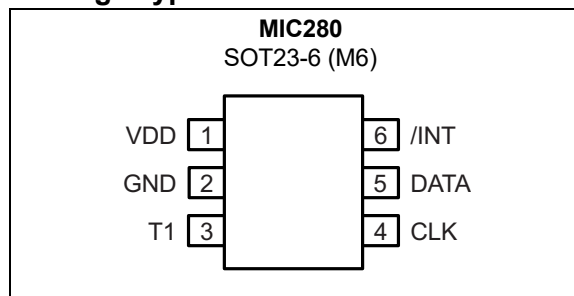

MIC280

Typical Application Circuit

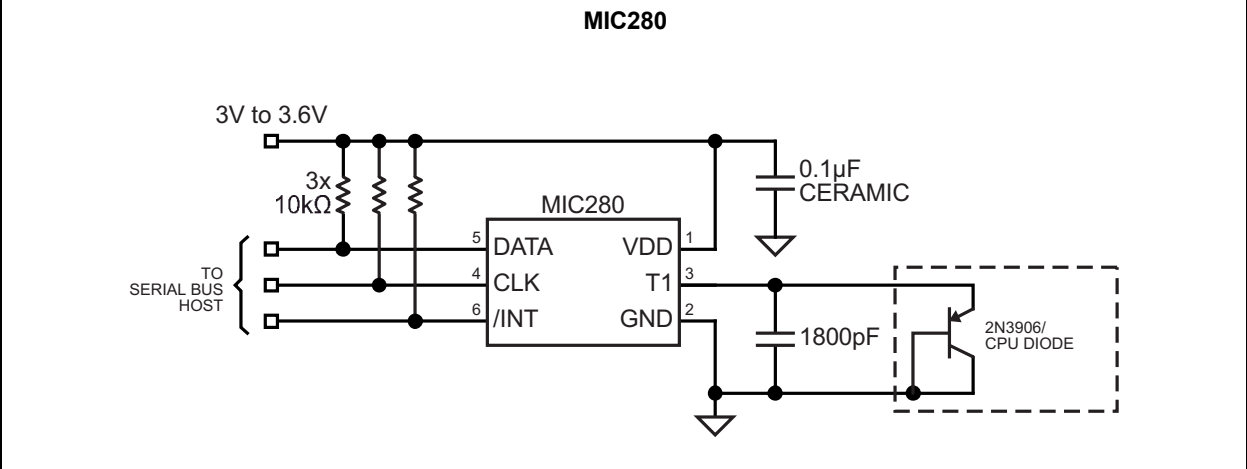

1.0 ELECTRICAL CHARACTERISTICS

Absolute Maximum Ratings †

Power Supply Voltage (V_{DD})	+3.8V
Voltage on T1	-0.3V to $V_{DD} + 0.3V$
Voltage on CLK, DATA, /INT	-0.3V to +6V
Current into any Pin	± 10 mA
Power Dissipation ($T_A = +125^\circ\text{C}$)	109 mW
ESD Rating (Human Body Model, Note 1)	1.5 kV
ESD Rating (Machine Model, Note 1)	200V

Operating Ratings ‡

Power Supply Voltage (V_{DD})	+3.0V to +3.6V
-----------------------------------	----------------

† Notice: Stresses above those listed under “Absolute Maximum Ratings” may cause permanent damage to the device. This is a stress rating only and functional operation of the device at those or any other conditions above those indicated in the operational sections of this specification is not intended. Exposure to maximum rating conditions for extended periods may affect device reliability.

‡ Notice: The device is not guaranteed to function outside its operating ratings. Final test on outgoing product is performed at $T_A = +25^\circ\text{C}$.

Note 1: Devices are ESD sensitive. Handling precautions are recommended. Human body model, 1.5 k Ω in series with 100 pF.

MIC280

ELECTRICAL CHARACTERISTICS

Electrical Characteristics: $V_{DD} = 3.3V$; $T_A = 25^\circ C$, unless noted. **Bold** values indicate $-55^\circ C \leq T_A \leq +125^\circ C$, $3.0V \leq V_{DD} \leq 3.6V$, unless noted. ([Note 1](#), [Note 2](#), [Note 3](#)).

Parameters	Symbol	Min.	Typ.	Max.	Units	Conditions
Power Supply						
Supply Current	I_{DD}	—	0.23	0.4	mA	/INT, T1 open; CLK = DATA = High; Normal mode
		—	9	—	μA	Shutdown mode; /INT, T1 open; Note 3 CLK = 100 kHz, DATA = High
		—	6	—	μA	Shutdown mode; /INT, T1 open; CLK = DATA = High
Power-On Reset Time Note 3	t_{POR}	—	200	—	μs	$V_{DD} > V_{POR}$
Power-On Reset Voltage	V_{POR}	—	2.65	2.95	V	All registers reset to default values; A/D conversions initiated
Power-on Reset Hysteresis Voltage Note 3	V_{HYST}	—	300	—	mV	—
Temperature-to-Digital Converter Characteristics						
Accuracy, Remote Temperature Note 4 , Note 6 , Note 9 , Note 10	—	—	± 0.25	± 1	$^\circ C$	$60^\circ C \leq T_D \leq 100^\circ C$ $3.15V < V_{DD} < 3.45V$, $25^\circ C < T_A < 85^\circ C$
		—	± 1	± 2	$^\circ C$	$0^\circ C \leq T_D \leq 100^\circ C$ $3.15V < V_{DD} < 3.45V$, $25^\circ C < T_A < 85^\circ C$
		—	± 2	± 4	$^\circ C$	$-55^\circ C \leq T_D \leq 125^\circ C$ $3.15V < V_{DD} < 3.45V$, $25^\circ C < T_A < 85^\circ C$
Accuracy, Local Temperature Note 4 , Note 9	—	—	± 1	± 2	$^\circ C$	$0^\circ C \leq T_A \leq 100^\circ C$, $3.15V < V_{DD} < 3.45V$
		—	± 1.5	± 2.5	$^\circ C$	$-55^\circ C \leq T_A \leq 125^\circ C$, $3.15V < V_{DD} < 3.45V$
Conversion Time Note 4 , Note 7	t_{CONV}	—	200	240	ms	RES[1:0]=00 (9 bits)
		—	330	390	ms	RES[1:0]=01 (10 bits)
		—	570	670	ms	RES[1:0]=10 (11 bits)
		—	1000	1250	ms	RES[1:0]=11 (12 bits)

Note 1: Specification for packaged product only.

2: Current into the /INT or DATA pins will result in self heating of the device. Sink current should be minimized for best accuracy.

3: Guaranteed by design over the operating temperature range. Not 100% production tested.

4: The device is not guaranteed to function outside its operating ratings. Final test on outgoing product is performed at $T_A = 25^\circ C$.

5: t_{INT} and t_{CRIT} are equal to t_{CONV} .

6: T_D is the temperature of the remote diode junction. Testing is performed using a single unit of one of the transistors listed in Table 8.

7: $t_{CONV} = t_{CONV(local)} + t_{CONV(remote)}$. Following the acquisition of either remote or local temperature data, the limit comparisons for that zone are performed and the device status updated. Status bits will be set and /INT driven active, if applicable.

8: The interrupt reset propagation delay is dominated by the capacitance on the bus.

9: Accuracy specification does not include quantization noise, which may be up to $\pm 1/2$ LSB.

10: Tested at 10-bit resolution.

ELECTRICAL CHARACTERISTICS (CONTINUED)

Electrical Characteristics: $V_{DD} = 3.3V$; $T_A = 25^\circ C$, unless noted. **Bold** values indicate $-55^\circ C \leq T_A \leq +125^\circ C$, $3.0V \leq V_{DD} \leq 3.6V$, unless noted. ([Note 1](#), [Note 2](#), [Note 3](#)).

Parameters	Symbol	Min.	Typ.	Max.	Units	Conditions
Remote Temperature Input, T1						
Current into External Diode, Note 3	I_F	—	192	400	μA	T1 forced to 1.0V, High level
		7	12	—	μA	Low level
Serial Data I/O Pin, DATA						
Low Output Voltage, Note 2	V_{OL}	—	—	0.3	V	$I_{OL} = 3 \text{ mA}$
		—	—	0.5	V	$I_{OL} = 6 \text{ mA}$
Low Input Voltage	V_{IL}	—	—	0.8	V	$3V \leq V_{DD} \leq 3.6V$
High Input Voltage	V_{IH}	2.1	—	5.5	V	$3V \leq V_{DD} \leq 3.6V$
Input Capacitance	C_{IN}	—	10	—	pF	Note 3
Input Current	I_{LEAK}	—	—	± 1	μA	—
Serial Clock Input, CLK						
Low Input Voltage	V_{IL}	—	—	0.8	V	$3V \leq V_{DD} \leq 3.6V$
High Input Voltage	V_{IH}	2.1	—	5.5	V	$3V \leq V_{DD} \leq 3.6V$
Input Capacitance	C_{IN}	—	10	—	pF	Note 3
Input Current	I_{LEAK}	—	—	± 1	μA	—
Interrupt Output, /INT						
Low Output Voltage, Note 2	V_{OL}	—	—	0.3	V	$I_{OL} = 3 \text{ mA}$
		—	—	0.5	V	$I_{OL} = 6 \text{ mA}$
Interrupt Propagation Delay, Note 3 , Note 5	t_{INT}	—	—	$[t_{CONV}]$	ms	From $TEMPx < TLOWx$ or $TEMPx > THIGHx$ or $TEMPx > CRITx$ to $/INT < VOL$, $R_{PULLUP} = 10 \text{ k}\Omega$
Interrupt Reset Propagation Delay, Note 3 , Note 8	t_{nINT}	—	—	1	μs	From read of STATUS or A.R.A. to $/INT > V_{OH}$, $R_{PULLUP} = 10 \text{ k}\Omega$
—	I_{LEAK}	—	—	± 1	μA	—

Note 1: Specification for packaged product only.

- 2:** Current into the /INT or DATA pins will result in self heating of the device. Sink current should be minimized for best accuracy.
- 3:** Guaranteed by design over the operating temperature range. Not 100% production tested.
- 4:** The device is not guaranteed to function outside its operating ratings. Final test on outgoing product is performed at $T_A = 25^\circ C$.
- 5:** t_{INT} and t_{CRIT} are equal to t_{CONV} .
- 6:** T_D is the temperature of the remote diode junction. Testing is performed using a single unit of one of the transistors listed in Table 8.
- 7:** $t_{CONV} = t_{CONV(local)} + t_{CONV(remote)}$. Following the acquisition of either remote or local temperature data, the limit comparisons for that zone are performed and the device status updated. Status bits will be set and /INT driven active, if applicable.
- 8:** The interrupt reset propagation delay is dominated by the capacitance on the bus.
- 9:** Accuracy specification does not include quantization noise, which may be up to $\pm 1/2$ LSB.
- 10:** Tested at 10-bit resolution.

MIC280

ELECTRICAL CHARACTERISTICS (CONTINUED)

Electrical Characteristics: $V_{DD} = 3.3V$; $T_A = 25^\circ C$, unless noted. **Bold** values indicate $-55^\circ C \leq T_A \leq +125^\circ C$, $3.0V \leq V_{DD} \leq 3.6V$, unless noted. ([Note 1](#), [Note 2](#), [Note 3](#)).

Parameters	Symbol	Min.	Typ.	Max.	Units	Conditions
Serial Interface Timing						
CLK (clock) Period	t_1	2.5	—	—	μs	—
Data In Setup Time to CLK High	t_2	100	—	—	ns	—
Data Out Stable after CLK Low	t_3	300	—	—	ns	—
Data Low Setup Time to CLK Low	t_4	100	—	—	ns	Start Condition
Data High Hold Time after CLK High	t_5	100	—	—	ns	Stop Condition
Bus Timeout	t_{TO}	25	30	35	ms	—

Note 1: Specification for packaged product only.

- 2:** Current into the /INT or DATA pins will result in self heating of the device. Sink current should be minimized for best accuracy.
- 3:** Guaranteed by design over the operating temperature range. Not 100% production tested.
- 4:** The device is not guaranteed to function outside its operating ratings. Final test on outgoing product is performed at $T_A = 25^\circ C$.
- 5:** t_{INT} and t_{CRIT} are equal to t_{CONV} .
- 6:** T_D is the temperature of the remote diode junction. Testing is performed using a single unit of one of the transistors listed in Table 8.
- 7:** $t_{CONV} = t_{CONV(local)} + t_{CONV(remote)}$. Following the acquisition of either remote or local temperature data, the limit comparisons for that zone are performed and the device status updated. Status bits will be set and /INT driven active, if applicable.
- 8:** The interrupt reset propagation delay is dominated by the capacitance on the bus.
- 9:** Accuracy specification does not include quantization noise, which may be up to $\pm 1/2$ LSB.
- 10:** Tested at 10-bit resolution.

Timing Diagram

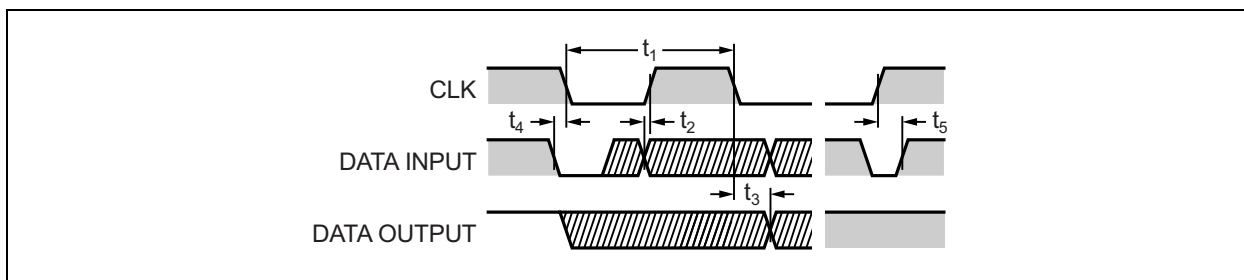

FIGURE 1-1: Serial Interface Timing.

TEMPERATURE SPECIFICATIONS

Parameters	Sym.	Min.	Typ.	Max.	Units	Conditions
Temperature Ranges						
Maximum Junction Temperature	T_J	—	—	+150	°C	Note 1
Storage Temperature Range	T_S	-65	—	+150	°C	—
Ambient Temperature Range	T_A	-55	—	+125	°C	—
Soldering	—	—	—	220 ⁺⁵ / ₋₀	°C	Vapor Phase, 60s
	—	—	—	235 ⁺⁵ / ₋₀	°C	Infrared, 15s
Package Thermal Resistances						
SOT23-6	θ_{JA}	—	230	—	°C/W	—

Note 1: The maximum allowable power dissipation is a function of ambient temperature, the maximum allowable junction temperature and the thermal resistance from junction to air (i.e., T_A , T_J , θ_{JA}). Exceeding the maximum allowable power dissipation will cause the device operating junction temperature to exceed the maximum +150°C rating. Sustained junction temperatures above +150°C can impact the device reliability.

2.0 TYPICAL PERFORMANCE CURVES

Note: The graphs and tables provided following this note are a statistical summary based on a limited number of samples and are provided for informational purposes only. The performance characteristics listed herein are not tested or guaranteed. In some graphs or tables, the data presented may be outside the specified operating range (e.g., outside specified power supply range) and therefore outside the warranted range.

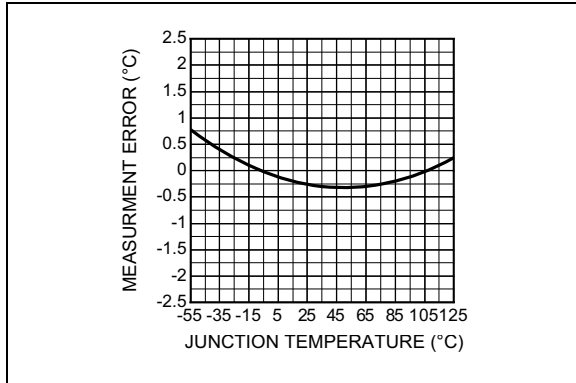

FIGURE 2-1: Accuracy vs. Temperature, Internal Sensor.

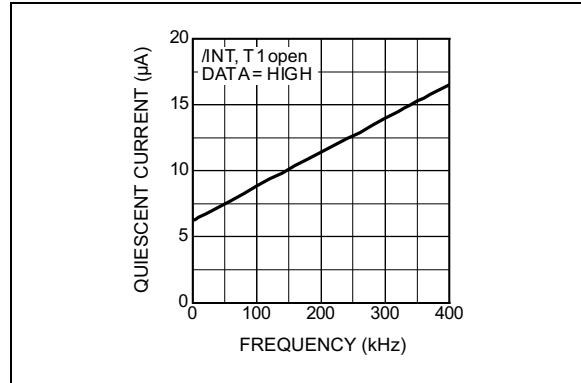

FIGURE 2-4: Quiescent Current vs. Clock Frequency in Shutdown Mode.

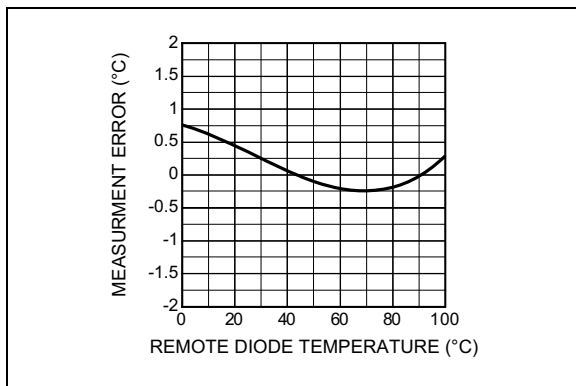

FIGURE 2-2: Remote Temperature Measurement Error.

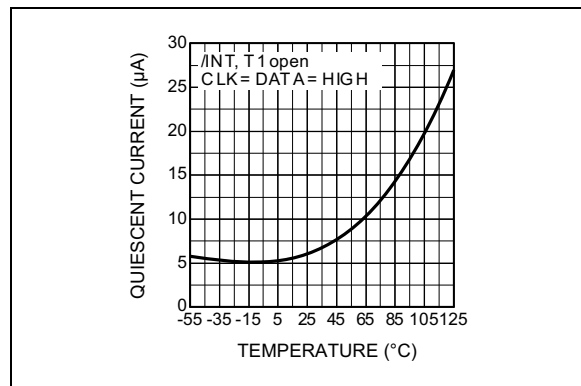

FIGURE 2-5: Quiescent Current vs. Temperature in Shutdown Mode.

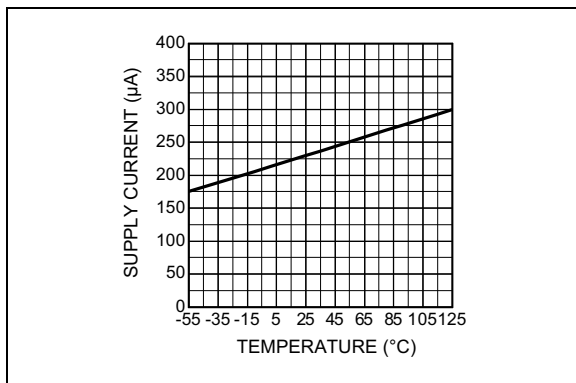

FIGURE 2-3: Supply Current vs. Temperature for $V_{DD} = 3.3V$.

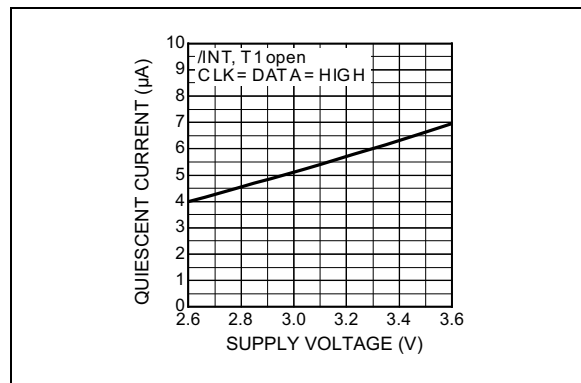

FIGURE 2-6: Quiescent Current vs. Supply Voltage in Shutdown Mode.

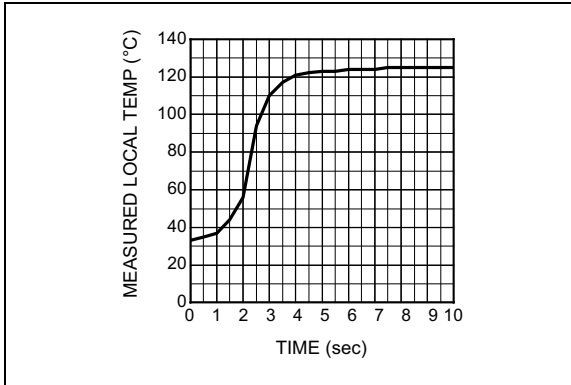

FIGURE 2-7: Response to Immersion in +125°C Fluid Bath.

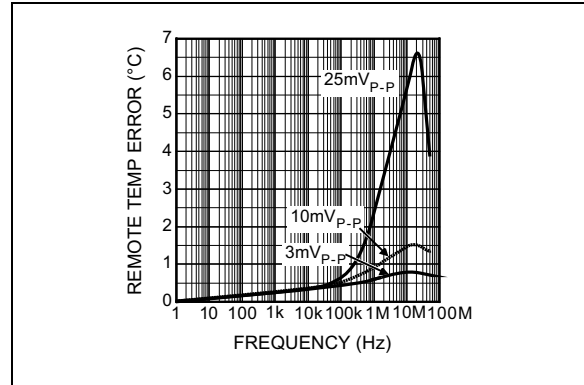

FIGURE 2-10: Noise Injected into the Base of Remote Transistor.

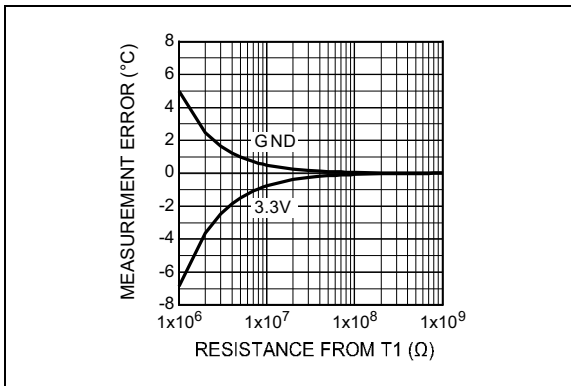

FIGURE 2-8: Measurement Error vs. PCB Leakage to +3.3V/GND.

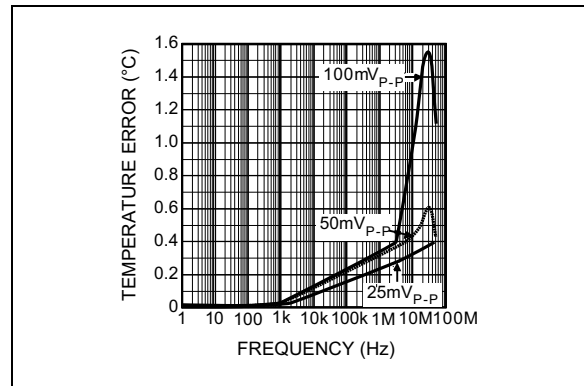

FIGURE 2-11: Noise Injected into the Collector of Remote Transistor.

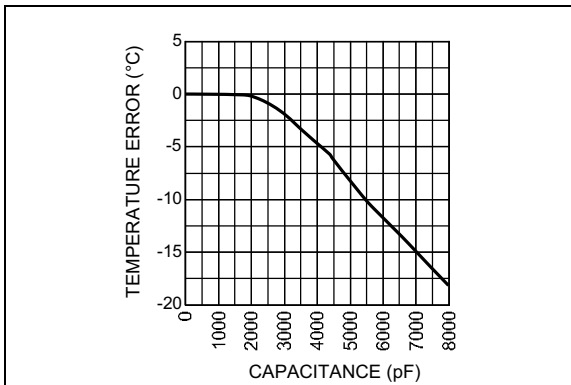

FIGURE 2-9: Remote Temperature Error vs. Capacitance on T1.

MIC280

3.0 PIN DESCRIPTIONS

The descriptions of the pins are listed in [Table 3-1](#).

TABLE 3-1: MIC841 PIN FUNCTION TABLE

Pin Number	Symbol	Description
1	VDD	Power supply input.
2	GND	Ground.
3	T1	Analog input. Connection to remote diode junction.
4	CLK	Digital input. Serial bit clock input.
5	DATA	Digital input/output. Open-drain. Serial data input/output.
6	/INT	Digital output. Open-drain. Interrupt output.

4.0 FUNCTIONAL DESCRIPTION

4.1 Serial Port Operation

The MIC280 uses standard SMBus Write_Byte, Read_Byte, and Read_Word operations for communication with its host. The SMBus Write_Byte operation involves sending the device's client address (with the R/W bit low, to signal a write operation), followed by a command byte and the data byte. The SMBus Read_Byte operation is a composite write and read operation: the host first sends the device's client address followed by the command byte, as in a write operation. A new start bit must then be sent to the MIC280, followed by a repeat of the client address with the R/W bit (LSB) set to the high (read) state. The data to be read from the part may then be clocked out. A Read_Word is similar, but two successive data bytes are clocked out rather than one. These protocols are shown in [Figure 4-1](#), [Figure 4-2](#), and [Figure 4-3](#).

The Command byte is eight bits (one byte) wide. This byte carries the address of the MIC280 register to be operated upon. The command byte values corresponding to the various MIC280 registers are shown in [Table 4-2](#). Other command byte values are reserved, and should not be used.

TABLE 4-2: MIC280 REGISTER ADDRESSES

Target Register		Command Byte Value		Power-On Default
Label	Description	Read	Write	
TEMP0	Local temperature result	00 _h	N/A	00 _h (0°C)
TEMP1h	Remote temperature result, high byte	01 _h	N/A	00 _h (0°C)
STATUS	Status	02 _h	N/A	00 _h
CONFIG	Configuration	03 _h	03 _h	80 _h
IMASK	Interrupt mask register	04 _h	04 _h	07 _h
THIGH0	Local temperature high limit	05 _h	05 _h	3C _h (60°C)
TLOW0	Local temperature low limit	06 _h	06 _h	00 _h (0°C)
THIGH1h	Remote temperature high limit, high byte	07 _h	07 _h	50 _h (80°C)
TLOW1h	Remote temperature low limit, high byte	08 _h	08 _h	00 _h (0°C)
LOCK	Security register	09 _h	09 _h	00 _h
TEMP1l	Remote temperature result, low byte	10 _h	N/A	00 _h
THIGH1l	Remote temperature high limit, low byte	13 _h	13 _h	00 _h
TLOW1l	Remote temperature low limit, low byte	14 _h	14 _h	00 _h
CRIT1	Remote overtemperature limit	19 _h	19 _h	64 _h (100°C)
CRIT0	Local overtemperature limit	20 _h	20 _h	46 _h (70°C)
MFG_ID	Manufacturer identification	FE _h	N/A	2A _h
DEV_ID	Device and revision identification	FF _h	N/A	0x _h (Note 1)

Note 1: The lower nibble contains the die revision level, (e.g., Rev. 0 = 00h).

4.2 Client Address

The MIC280 will only respond to its own unique client address. A match between the MIC280's address and the address specified in the serial bit stream must be made to initiate communication. The MIC280's client address is fixed at the time of manufacture. Eight different client addresses are available as determined by the part number. See [Table 4-1](#) and the [Product Identification System](#) section.

TABLE 4-1: MIC280 CLIENT ADDRESSES

Part Number	Client Address
MIC280-0YM6	100 1000 _b = 48 _h
MIC280-1YM6	100 1001 _b = 49 _h
MIC280-2YM6	100 1010 _b = 4A _h
MIC280-3YM6	100 1011 _b = 4B _h
MIC280-4YM6	100 1100 _b = 4C _h
MIC280-5YM6	100 1101 _b = 4D _h
MIC280-6YM6	100 1110 _b = 4E _h
MIC280-7YM6	100 1111 _b = 4F _h

MIC280

4.3 Alert Response Address

In addition to the Read_Byte, Write_Byte, and Read_Word protocols, the MIC280 adheres to the SMBus protocol for response to the Alert Response Address (A.R.A.). The MIC280 expects to be interrogated using the ARA when it has asserted its /INT output.

4.4 Temperature Data Format

The least-significant bit of each temperature register (high bytes) represents one degree Centigrade. The values are in a two's complement format, wherein the most significant bit (D7) represents the sign: zero for positive temperatures and one for negative temperatures. Table 4-3 shows examples of the data used by the MIC280 for temperatures.

TABLE 4-3: TEMPERATURE FORMAT, HIGH BYTES

Temperature	Binary	Hex
+127°C	0111 1111	7F
+125°C	0111 1101	7D
+25°C	0001 1001	19
+1°C	0000 0001	01
0°C	0000 0000	00
-1°C	1111 1111	FF
-25°C	1110 0111	E7
-125°C	1000 0011	83
-128°C	1000 0000	80

Extended temperature resolution is provided for the external zone. The high and low temperature limits and the measured temperature for zone one are reported as 12-bit values stored in a pair of 8-bit registers. The measured temperature, for example, is reported in registers TEMP1h, the high-order byte, and TEMP1l, the low-order byte. The values in the low-order bytes are left-justified four-bit binary values representing one-sixteenth degree increments.

TABLE 4-5: DIGITAL TEMPERATURE FORMAT, LOW BYTES

Extended Temperature Low Byte	Resolution			
	9 Bits	10 Bits	11 Bits	12 Bits
	Binary – Hex	Binary – Hex	Binary – Hex	Binary – Hex
0.0000	0000 0000 – 00	0000 0000 – 00	0000 0000 – 00	0000 0000 – 00
0.0625	0000 0000 – 00	0000 0000 – 00	0000 0000 – 00	0001 0000 – 10
0.1250	0000 0000 – 00	0000 0000 – 00	0010 0000 – 20	0010 0000 – 20
0.2500	0000 0000 – 00	0100 0000 – 40	0100 0000 – 40	0100 0000 – 40
0.5625	1000 0000 – 80	1000 0000 – 80	1000 0000 – 80	1001 0000 – 90
0.9375	1000 0000 – 80	1100 0000 – C0	1110 0000 – E0	1111 0000 – F0

The A-D converter resolution for zone one is selectable from nine to twelve bits via the configuration register. Low-order bits beyond the resolution selected will be reported as zeroes. Examples of this format are shown in Table 4-5.

4.5 Fault Queue

A set of fault queues (programmable digital filters) are provided in the MIC280 to prevent false tripping due to thermal or electrical noise. Two bits, CONFIG[5:4], set the depth of the fault queues. The fault queue setting then determines the number of consecutive temperature events (TEMPx > THIGHx or TEMPx < TLOWx) which must occur in order for the condition to be considered valid. As an example, assume CONFIG[5:4] is programmed with 10b. The measured temperature for a given zone would have to exceed THIGHx for four consecutive A/D conversions before /INT would be asserted or the status bit set.

Like any filter, the fault queue function also has the effect of delaying the detection of temperature events. In this example, it would take 4 × tCONV to detect a temperature event. The fault queue depth versus CONFIG[5:4] of the configuration register is shown in Table 4-4. Note that there is no fault queue for overtemperature events (CRIT0 and CRIT1) or diode faults. The fault queue applies only to high-temperature and low-temperature events as determined by the THIGHx and TLOWx registers. Any write to CONFIG will result in the fault queues being purged and reset. Writes to any of the limit registers, TLOWx or THIGHx, will result in the fault queue for the corresponding zone being purged and reset.

TABLE 4-4: FAULT QUEUE DEPTH SETTINGS

CONFIG[5:4]	Fault Queue Depth
00	1 (default)
01	2
10	4
11	6

4.6 Interrupt Generation

There are eight different conditions that will cause the MIC280 to set one of the bits in STATUS and assert its /INT output, if so enabled. These conditions are listed in Table 4-6. Unlike previous generations of thermal supervisor ICs, there are no interdependencies between any of these conditions. That is, if CONDITION is true, the MIC280 will respond accordingly, regardless of any previous or currently pending events.

Normally when a temperature event occurs, the corresponding status bit will be set in STATUS, the corresponding interrupt mask bit will be cleared, and /INT will be asserted. Clearing the interrupt mask bit(s) prohibits continuous interrupt generation while the device is being serviced. It is possible to prevent events from clearing interrupt mask bits by setting bits in the lock register. See Table 4-7 for Lockbit functionality. A temperature event will only set bits in the status register if it is specifically enabled by the corresponding bit in the interrupt mask register. An interrupt signal will only be generated on /INT if interrupts are also globally enabled (IE = 1 in CONFIG).

The MIC280 expects to be interrogated using the Alert Response Address once it has asserted its interrupt output. Following an interrupt, a successful response to the A.R.A. or a read operation on STATUS will cause /INT to be de-asserted. STATUS will also be cleared by the read operation. Reading STATUS following an interrupt is an acceptable substitute for using the A.R.A. if the host system does not implement the A.R.A. protocol. Figure 4-4 and Figure 4-5 illustrate these two methods of responding to MIC280 interrupts.

Because temperature-to-digital conversions continue while /INT is asserted, the measured temperature could change between the MIC280's assertion of /INT and the host's response. It is good practice for the interrupt service routine to read the value in TEMPx to verify that the overtemperature or undertemperature condition still exists. In addition, more than one temperature event may have occurred simultaneously or in rapid succession between the assertion of /INT and servicing of the MIC280 by the host. The interrupt service routine should allow for this eventuality. At the end of the interrupt service routine, the interrupt enable bits should be reset to permit future interrupts.

4.7 Reading the Result Registers

All MIC280 registers are eight bits wide and may be accessed using the standard Read_Byte protocol. The temperature result for the local zone, zone 0, is a single 8-bit value in register TEMP0. A single Read_Byte operation by the host is sufficient for retrieving this value. The temperature result for the remote zone is a twelve-bit value split across two eight-bit registers, TEMP1h and TEMP1l. A series of two Read_Byte operations are needed to obtain the entire twelve-bit

temperature result for zone 1. It is possible under certain conditions that the temperature result for zone 1 could be updated between the time TEMP1l or TEMP1h is read and the companion register is read. In order to ensure coherency, TEMP1h supports the use of the Read_Word protocol for accessing both TEMP1h and TEMP1l with a single operation. This ensures that the values in both result registers are from the same ADC cycle. This is illustrated in Figure 4-3. Read_Word operations are only supported for TEMP1h: TEMP1l, i.e., only for command byte values of 01h.

4.8 Polling

The MIC280 may either be polled by the host or request the host's attention via the /INT pin. In the case of polled operation, the host periodically reads the contents of STATUS to check the state of the status bits. The act of reading STATUS clears it. If more than one event that sets a given status bit occurs before the host polls STATUS, only the fact that at least one such event has occurred will be apparent to the host. For polled systems, the global interrupt enable bit should be clear (IE = 0). This will disable interrupts from the MIC280 (prevents the /INT pin from sinking current). For interrupt-driven systems, IE must be set to enable the /INT output.

4.9 Shutdown Mode

Putting the device into shutdown mode by setting the shutdown bit in the configuration register will unconditionally deassert /INT, clear STATUS, and purge the fault queues. Therefore, this should not be done before completing the appropriate interrupt service routine(s). No other registers will be affected by entering shutdown mode. The last temperature readings will persist in the TEMPx registers.

The MIC280 can be prevented from entering shutdown mode using the shutdown lockout bit in the lock register. If L3 in LOCK is set while the MIC280 is in shutdown mode, it will immediately exit shutdown mode and resume normal operation. It will not be possible to subsequently re-enter shutdown mode. If the reset bit is set while the MIC280 is shut down, normal operation resumes from the reset state.

4.10 Warm Resets

The MIC280 can be reset to its power-on default state during operation by setting the RST bit in the configuration register. When this bit is set, /INT will be deasserted, the fault queues will be purged, the limit registers will be restored to their normal power-on default values, and any A/D conversion in progress will be halted and the results discarded. This includes resetting bits L3 through L0 in the security register, LOCK. The state of the MIC280 following this operation is indistinguishable from a power-on reset. If the reset

MIC280

bit is set while the MIC280 is shut down, the shutdown bit is cleared and normal operation resumes from the reset state.

If bit 4 of LOCK, the Warm Reset Lockout Bit, is set, warm resets cannot be initiated, and writes to the RST bit will be completely ignored. Setting L4 while the MIC280 is shut down will result in the device exiting shutdown mode and resuming normal operation, just as if the shutdown bit had been cleared.

TABLE 4-6: MIC280 TEMPERATURE EVENTS

Event	Condition	MIC280 Response (Note 1)
Data ready	A/D conversions complete for both zones; result registers updated; state of /INT updated	Set S7, clear IM7, assert /INT
Overtemperature, remote	$([TEMP1h:TEMP1l]) > CRIT1$	Set S1, assert /INT
Overtemperature, local	$TEMP0 > CRIT0$	Set S0, assert /INT
High temperature, remote	$([TEMP1h:TEMP1l]) > [THIGH1h:THIGH1l]$ (Note 2)	Set S4, clear IM4, assert /INT
High temperature, local	$TEMP0 > THIGH0$ (Note 2)	Set S6, clear IM6, assert /INT
Low temperature, remote	$([TEMP1h:TEMP1l]) < [TLOW1h:TLOW1l]$ (Note 2)	Set S3, clear IM3, assert /INT
Low temperature, local	$TEMP0 < TLOW0$ (Note 2)	Set S5, clear IM5, assert /INT
Diode fault	T1 open or T1 shorted to VDD or GND	Set S2, clear IM2, assert /INT

Note 1: Assumes interrupts enabled.

2: CONDITION must be true for Fault_Queue conversions to be recognized.

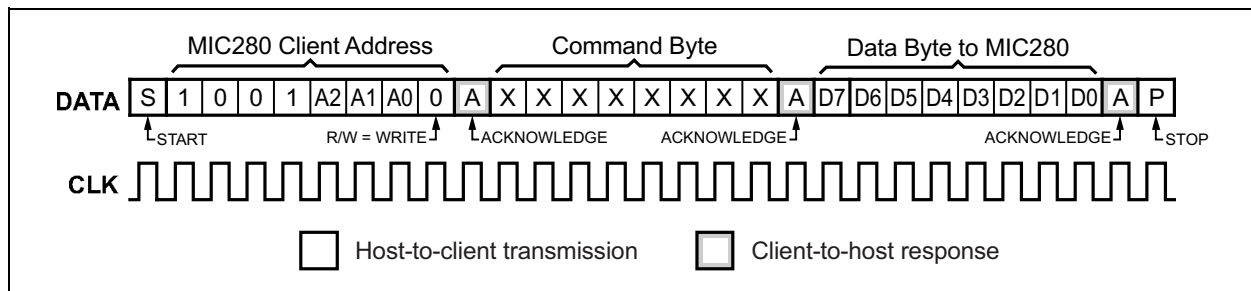

FIGURE 4-1: WRITE_BYTE Protocol.

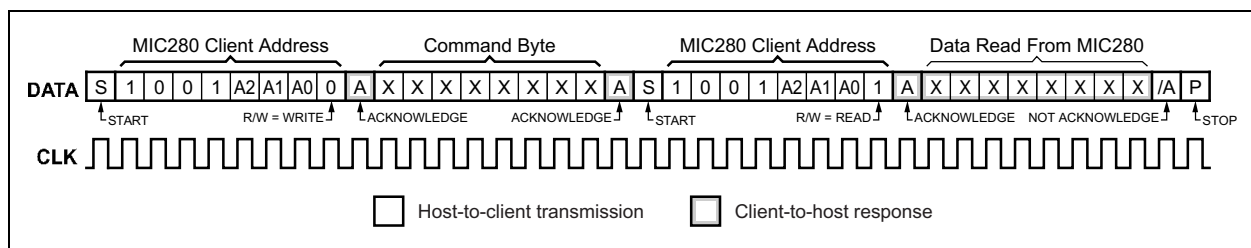

FIGURE 4-2: READ_BYTE Protocol.

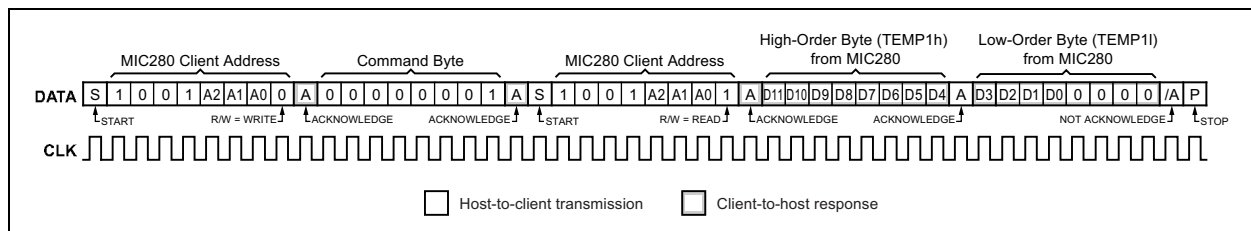

FIGURE 4-3: READ_WORD Protocol for Accessing TEMP1h:TEMP1l.

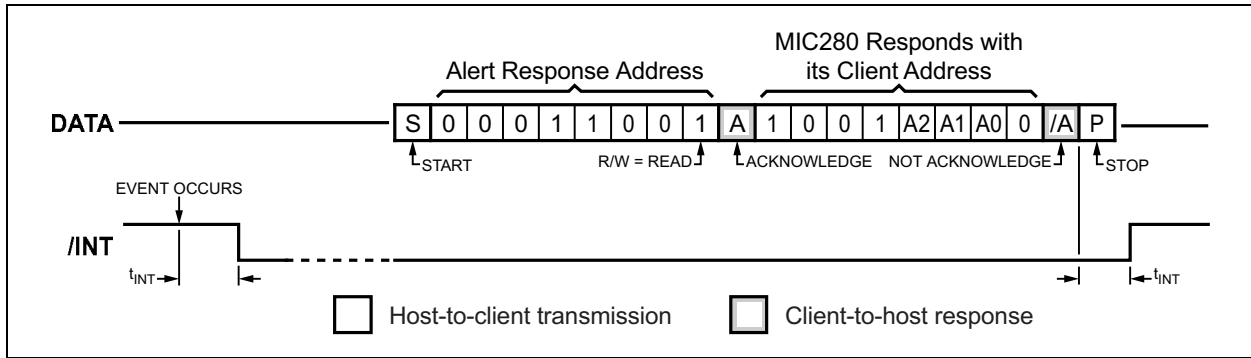

FIGURE 4-4: MIC280 Alert Response Address Protocol.

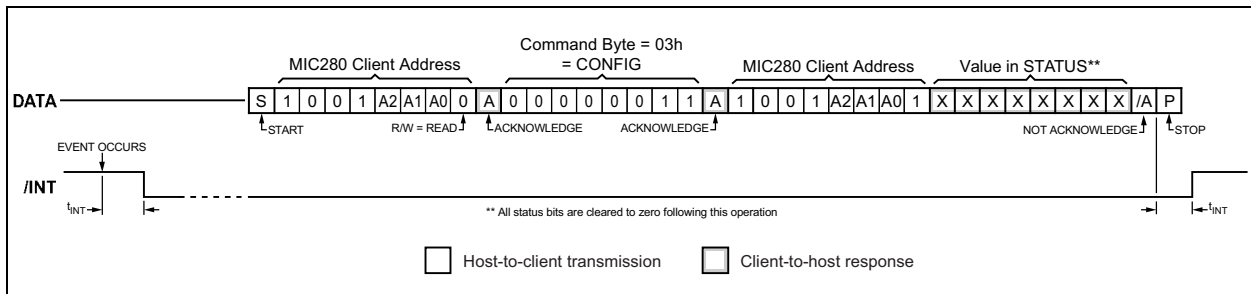

FIGURE 4-5: Reading Status in Response to an Interrupt.

4.11 Configuration Locking

The security register, LOCK, provides the ability to disable configuration changes as they apply to the MIC280's most critical functions: shutdown mode, and reporting diode faults and overtemperature events. LOCK provides a way to prevent malicious or accidental changes to the MIC280 registers that might prevent a system from responding properly to critical events. Once L0, L1, or L2 has been set, the global interrupt enable bit, IE, will be set and fixed. It cannot subsequently be cleared. Its state will be reflected in the configuration register. The bits in LOCK can only be set once. That is, once a bit is set, it cannot be reset until the MIC280 is power-cycled or a warm reset is performed by setting RST in the configuration register. The warm reset function can be disabled by setting L4 in LOCK. If L4 is set, locked settings cannot be changed during operation and warm resets cannot be performed; only a power-cycle will reset the locked state(s).

If L0 is set, the values of IM0 and CRIT0 become fixed and unchangeable. That is, writes to CRIT0 and the corresponding interrupt enable bit are locked out.

A local overtemperature event will generate an interrupt regardless of the setting of IE or its interrupt mask bit.

If L1 is set, the values of IM1 and CRIT1 become fixed and unchangeable. A remote over-temperature event will generate an interrupt regardless of the setting of IE or its interrupt mask bit. Similarly, setting L2 will fix the state of IM2, allowing the system to permanently

enable or disable diode fault interrupts. A diode fault will generate an interrupt regardless of the setting of IE or its interrupt mask bit.

L3 can be used to lock out shutdown mode. If L3 is set, the MIC280 will not shut down under any circumstances. Attempts to set the SHDN bit will be ignored and all chip functions will remain operational. If L3 is set while the MIC280 is in shutdown mode, it will immediately exit shutdown mode and resume normal operation. It will not be possible to subsequently re-enter shutdown mode.

Setting L4 disables the RST bit in the configuration register, preventing the host from initiating a warm reset. Writes to RST will be completely ignored if L4 is set.

MIC280

TABLE 4-7: LOCK BIT FUNCTIONALITY

Lock Bit	Function Locked	Response When Set
L0	Local overtemperature detection	IM0 fixed at 1, writes to CRIT0 locked-out; IE permanently set
L1	Remote overtemperature detection	IM1 fixed at 1; writes to CRIT1 locked-out; IE permanently set
L2	Diode fault interrupts locked on or off	IM2 fixed at current state; IE permanently set if IM2=1
L3	Shutdown Mode	SHDN fixed at 0; exit shutdown if SHDN=1 when L3 is set
L4	Warm Resets	RST bit disabled; cannot initiate warm resets

5.0 DETAILED REGISTER DESCRIPTIONS

5.1 Local Temperature Result Register (TEMP0) 8-Bits, Read-Only

TABLE 5-1: TEMPERATURE DATA FROM ADC

Local Temperature Result Register							
D[7] read-only	D[6] read-only	D[5] read-only	D[4] read-only	D[3] read-only	D[2] read-only	D[1] read-only	D[0] read-only
Bit		Function				Operation	
D[7:0]		Measured temperature data for the local zone.				Read-only	

Power-up default value: 0000 0000_b = 00_h = (0°C)

Note that TEMP0 will contain measured temperature data after the completion of one conversion.

Read command byte: 0000 0000_b = 00_h

Each LSB represents one degree centigrade. The values are in a twos complement binary format such that 0°C is reported as 0000 0000_b. See the [Temperature Data Format](#) section for more details.

5.2 Remote Temperature Result High Byte Register (TEMP1h) 8-Bits, Read-Only

TABLE 5-2: TEMPERATURE DATA FROM ADC

Remote Temperature Result High Byte Register							
D[7] read-only	D[6] read-only	D[5] read-only	D[4] read-only	D[3] read-only	D[2] read-only	D[1] read-only	D[0] read-only
Bit		Function				Operation	
D[7:0]		Measured temperature data for the remote zone, most significant byte.				Read-only	

Power-up default value: 0000 0000_b = 00_h = (0°C)

Note that TEMP0 will contain measured temperature data after the completion of one conversion.

Read command byte: 0000 0001_b = 01_h

Each LSB represents one degree centigrade. The values are in a twos complement binary format such that 0°C is reported as 0000 0000_b. See the [Temperature Data Format](#) section for more details.

TEMP1h can be read using either a Read_Byte operation or a Read_Word operation. Using Read_Byte will yield the 8-bit value in TEMP1h. The complete remote temperature result in both TEMP1h and TEMP1l may be obtained by performing a Read_Word operation on TEMP1h. The MIC280 will respond to a Read_Word with a command byte of 01h (TEMP1h) by returning the value in TEMP1h followed by the value in TEMP1l. This guarantees that the data in both registers is from the same temperature-to-digital conversion cycle. The Read_Word operation is diagrammed in [Figure 4-3](#). This is the only MIC280 register that supports Read_Word.

MIC280

5.3 Status Register (STATUS) 8-Bits, Read-Only

TABLE 5-3: STATUS REGISTER INFORMATION

Status Register							
D[7] read-only	D[6] read-only	D[5] read-only	D[4] read-only	D[3] read-only	D[2] read-only	D[1] read-only	D[0] read-only
S7	S6	S5	S4	S3	S2	S1	S0
Bit		Function				Operation (Note 1)	
S7		Data ready				1 = data available, 0 = ADC busy	
S6		Local high temperature event				1 = event occurred, 0 = none	
S5		Local low temperature event				1 = event occurred, 0 = none	
S4		Remote high temperature event				1 = event occurred, 0 = none	
S3		Remote low temperature event				1 = event occurred, 0 = none	
S2		Diode fault				1 = fault, 0 = none	
S1		Remote overtemperature event				1 = event occurred, 0 = none	
S0		Local overtemperature event				1 = event occurred, 0 = none	

Note 1: All status bits are cleared after any read operation is performed on STATUS.

Power-up default value: $0000\ 0000_b = 00_h$ = (no events pending)

Read command byte: $0000\ 0010_b = 02_h$

The power-up default value is 00h. Following the first conversion, however, any of the status bits may be set depending on the measured temperature results or the existence of a diode fault.

5.4 Configuration Register (CONFIG) 8-Bits, Read/Write

TABLE 5-4: CONFIGURATION REGISTER INFORMATION

Configuration Register							
D[7] read/write	D[6] read/write	D[5] reserved	D[4] reserved	D[3] reserved	D[2] reserved	D[1] reserved	D[0] reserved
Interrupt Enable (IE)	Shutdown (SHDN)	Fault Queue (FQ[1:0])		Resolution (RES[1:0])		Reserved	Reset (RST)
Bit		Function				Operation	
IE		Interrupt enable				1 = interrupts enabled, 0 = disabled	
SHDN		Selects operating mode: normal/shutdown				1 = shutdown, 0 = normal	
FQ[1:0]		Depth of fault queue				[00] = 1, [01] = 2, [10] = 4, [11] = 6	
RES[1:0]		A/D converter resolution for external zone; affects conversion rate				[00] = 9-bits, [01] = 10-bits, [10] = 11-bits, [11] = 12-bits	
D[1]		Reserved				Always write as zero	
RST		Resets all MIC280 functions and restores the power-up default state				Write only; 1 = reset, 0 = normal Operation; disabled by setting L4	

Any write to CONFIG will result in the fault queues being purged and reset and any A/D conversion in progress being aborted and the result discarded. The A/D will begin a new conversion sequence once the write operation is complete.

Power-up default value: $1000\ 0000_b = 80_h$ (not in shutdown mode; interrupts enabled; fault queue depth = 1; resolution = 9-bits)

Read/write command byte: $0000\ 0011_b = 03_h$

5.5 Interrupt Mask Register (IMASK) 8-Bits, Read/Write

TABLE 5-5: INTERRUPT MASK REGISTER INFORMATION

Interrupt Mask Register							
D[7] read/write	D[6] read/write	D[5] reserved	D[4] reserved	D[3] reserved	D[2] reserved	D[1] reserved	D[0] reserved
IM7	IM6	IM5	IM4	IM3	IM2	IM1	IM0
Bit		Function				Operation	
IM7		Data-ready event mask				1 = enabled, 0 = disabled	
IM6		Local high temperature event mask				1 = enabled, 0 = disabled	
IM5		Local low temperature event mask				1 = enabled, 0 = disabled	
IM4		Remote high temperature event mask				1 = enabled, 0 = disabled	
IM3		Remote low temperature event mask				1 = enabled, 0 = disabled	
IM2		Diode fault mask				1 = enabled, 0 = disabled	
IM1		Remote overtemperature event mask				1 = enabled, 0 = disabled	
IM0		Local overtemperature event mask				1 = enabled, 0 = disabled	

Power-up default value: $0000\ 0111_b = 07_h$ (overtemperature and diode faults enabled)

Read/write command byte: $0000\ 0100_b = 04_h$

5.6 Local Temperature High Limit Register (THIGH0) 8-Bits, Read/Write

TABLE 5-6: LOCAL TEMPERATURE HIGH LIMIT REGISTER INFORMATION

Local Temperature High Limit Register							
D[7] read/write	D[6] read/write	D[5] read/write	D[4] read/write	D[3] read/write	D[2] read/write	D[1] read/write	D[0] read/write
High temperature limit for local zone.							
Bit		Function				Operation	
D[7:0]		High temperature limit for the local zone.				Read/write	

Power-up default value: $0011\ 1100_b = 3C_h$ (60°C)

Read/write command byte: $0000\ 0101_b = 05_h$

Each LSB represents one degree centigrade. The values are in a two's complement binary format such that 0°C is reported as $0000\ 0000_b$. See the [Temperature Data Format](#) section for more details.

Any writes to a temperature limit register will result in the corresponding fault queue being purged and reset.

5.7 Local Temperature Low Limit Register (TLOW0) 8-Bits, Read/Write

TABLE 5-7: LOCAL TEMPERATURE LOW LIMIT REGISTER INFORMATION

Local Temperature Low Limit Register							
D[7] read/write	D[6] read/write	D[5] read/write	D[4] read/write	D[3] read/write	D[2] read/write	D[1] read/write	D[0] read/write
Low temperature limit for the local zone.							
Bit		Function				Operation	
D[7:0]		Low temperature limit for the local zone.				Read/Write	

Power-up default value: 0000 0000_b = 00_h (0°C)

Read/write command byte: 0000 0110_b = 06_h

Each LSB represents one degree centigrade. The values are in a two's complement binary format such that 0°C is reported as 0000 0000_b. See the [Temperature Data Format](#) section for more details.

Any writes to a temperature limit register will result in the corresponding fault queue being purged and reset.

5.8 Remote Temperature High Limit High-Byte Register (THIGH1h) 8-Bits, Read/Write

TABLE 5-8: REMOTE TEMPERATURE HIGH LIMIT HIGH-BYTE REGISTER INFORMATION

Remote Temperature High Limit High-Byte Register							
D[7] read/write	D[6] read/write	D[5] read/write	D[4] read/write	D[3] read/write	D[2] read/write	D[1] read/write	D[0] read/write
High temperature limit for remote zone, most significant byte.							
Bit		Function				Operation	
D[7:0]		High temperature limit for remote zone, most significant byte.				Read/Write	

Power-up default value: 0101 0000_b = 50_h (80°C)

Read/write command byte: 0000 0111_b = 07_h

Each LSB represents one degree centigrade. The values are in a two's complement binary format such that 0°C is reported as 0000 0000_b. See the [Temperature Data Format](#) section for more details.

Any writes to a temperature limit register will result in the corresponding fault queue being purged and reset.

5.9 Remote Temperature Low Limit High-Byte Register (TLOW1h) 8-Bits, Read/Write

TABLE 5-9: REMOTE TEMPERATURE LOW LIMIT HIGH-BYTE REGISTER INFORMATION

Remote Temperature Low Limit High-Byte Register							
D[7] read/write	D[6] read/write	D[5] read/write	D[4] read/write	D[3] read/write	D[2] read/write	D[1] read/write	D[0] read/write
Low temperature limit for remote zone, most significant byte.							
Bit		Function				Operation	
D[7:0]		Low temperature limit for remote zone, most significant byte.				Read/Write	

Power-up default value: 0000 0000_b = 00_h (0°C)

Read/write command byte: 0000 1000_b = 08_h

Each LSB represents one degree centigrade. The values are in a two's complement binary format such that 0°C is reported as 0000 0000_b. See the [Temperature Data Format](#) section for more details.

Any writes to a temperature limit register will result in the corresponding fault queue being purged and reset.

5.10 Security Register (LOCK) 8-Bits, Write Once

TABLE 5-10: SECURITY REGISTER INFORMATION

Security Register							
D[7] reserved	D[6] reserved	D[5] reserved	D[4] read/write- once	D[3] read/write- once	D[2] read/write- once	D[1] read/write- once	D[0] read/write- once
Reserved			L4	L3	L2	L1	L0
Bit		Function				Operation	
D[7:5]		Reserved				Always write as zero	
L4		Warm-reset lockout bit				1 = RST bit disabled; 0 = unlocked	
L3		Shutdown mode lockout bit				1 = shutdown disabled; 0 = unlocked	
L2		Diode fault event lock bit				1 = locked; 0 = unlocked	
L1		Remote overtemperature event lock bit				1 = locked; 0 = unlocked	
L0		Local overtemperature event lock bit				1 = locked; 0 = unlocked	

Power-up default value: 0000 0000_b = 00_h (all event unlocked)

Write command byte: 0000 1001_b = 09_h

5.11 Remote Temperature Result Low-Byte Register (TLOW1I) 8-Bits, Read Only

TABLE 5-11: REMOTE TEMPERATURE RESULT LOW-BYTE REGISTER INFORMATION

Remote Temperature Result Low-Byte Register							
D[7] read-only	D[6] read-only	D[5] read-only	D[4] read-only	D[3] reserved	D[2] reserved	D[1] reserved	D[0] reserved
Temperature data from ADC, least significant bits. Reserved always reads zero.							
Bit		Function				Operation	
D[7:4]		Measured temperature data for the remote zone, least significant bits.				Read only	
D[3:0]		Reserved				Always reads as zero	

Power-up default value: 0000 0000_b = 00_h (0°C). TEMP1I will contain measured temperature data after the completion of one conversion.

Read command byte: 0001 0000_b = 10_h

Each LSB represents one-sixteenth degree centigrade. The values are in a binary format such that 1/16th°C (0.0625°C) is reported as 0001 0000_b. See the [Temperature Data Format](#) section for more details.

TEMP1I can be accessed using a Read_Byte operation. However, the complete remote temperature result in both TEMP1h and TEMP1I may be obtained by performing a Read_Word operation on TEMP1h. The MIC280 will respond to a Read_Word with a command byte of 01h (TEMP1h) by returning the value in TEMP1h followed by the value in TEMP1I. This guarantees that the data in both registers is from the same temperature-to-digital conversion cycle. The Read_Word operation is diagrammed in [Figure 4-3](#). TEMP1h is the only MIC280 register that supports Read_Word.

5.12 Remote Temperature High Limit Low-Byte Register (THIGH1I) 8-Bits, Read/Write

TABLE 5-12: REMOTE TEMPERATURE HIGH LIMIT LOW-BYTE REGISTER INFORMATION

Remote Temperature High Limit Low-Byte Register							
D[7] read/write	D[6] read/write	D[5] read/write	D[4] read/write	D[3] reserved	D[2] reserved	D[1] reserved	D[0] reserved
High temperature limit for remote zone, least significant bits. Reserved always reads zero.							

MIC280

TABLE 5-12: REMOTE TEMPERATURE HIGH LIMIT LOW-BYTE REGISTER INFORMATION

Remote Temperature High Limit Low-Byte Register		
Bit	Function	Operation
D[7:4]	High temperature limit for the remote zone, least significant bits.	Read/Write
D[3:0]	Reserved	Always reads as zero

Power-up default value: 0000 0000_b = 00_h (0°C)

Read/write command byte: 0001 0011_b = 13_h

Each LSB represents one-sixteenth degree centigrade. The values are in a binary format such that 1/16th°C (0.0625°C) is reported as 0001 0000_b. See the [Temperature Data Format](#) section for more details.

Any writes to a temperature limit register will result in the corresponding fault queue being purged and reset.

5.13 Remote Temperature Low Limit Low-Byte Register (TLOW1I) 8-Bits, Read/Write

TABLE 5-13: REMOTE TEMPERATURE LOW LIMIT LOW-BYTE REGISTER INFORMATION

Remote Temperature Low Limit Low-Byte Register							
D[7]	D[6]	D[5]	D[4]	D[3]	D[2]	D[1]	D[0]
read/write	read/write	read/write	read/write	reserved	reserved	reserved	reserved
Low temperature limit for remote zone, least significant bits. Reserved always reads zero.							
Bit	Function						Operation
D[7:4]	Low temperature limit for the remote zone, least significant bits.						Read/Write
D[3:0]	Reserved						Always reads as zero

Power-up default value: 0000 0000_b = 00_h (0°C)

Read/write command byte: 0001 0100_b = 14_h

Each LSB represents one-sixteenth degree centigrade. The values are in a binary format such that 1/16th°C (0.0625°C) is reported as 0001 0000_b. See the [Temperature Data Format](#) section for more details.

Any writes to a temperature limit register will result in the corresponding fault queue being purged and reset.

5.14 Remote Overtemperature Limit Register (CRIT1) 8-Bits, Read/Write

TABLE 5-14: REMOTE OVERTEMPERATURE LIMIT REGISTER INFORMATION

Remote Overtemperature Limit Register							
D[7]	D[6]	D[5]	D[4]	D[3]	D[2]	D[1]	D[0]
read/write	read/write	read/write	read/write	read/write	read/write	read/write	read/write
Overtemperature limit for remote zone.							
Bit	Function						Operation
D[7:0]	Overtemperature limit for the remote zone.						Read/Write

Power-up default value: 0110 0100_b = 64_h (100°C)

Read/write command byte: 0001 1001_b = 19_h

Each LSB represents one degree centigrade. The values are in a two's complement binary format such that 0°C is reported as 0000 0000_b. See the [Temperature Data Format](#) section for more details.

Any writes to a temperature limit register will result in the corresponding fault queue being purged and reset.

5.15 Local Overtemperature Limit Register (CRIT0) 8-Bits, Read/Write

TABLE 5-15: LOCAL OVERTEMPERATURE LIMIT REGISTER INFORMATION

Local Overtemperature Limit Register							
D[7] read/write	D[6] read/write	D[5] read/write	D[4] read/write	D[3] read/write	D[2] read/write	D[1] read/write	D[0] read/write
Overtemperature limit for local zone.							
Bit		Function				Operation	
D[7:0]		Overtemperature limit for local zone.				Read/Write	

Power-up default value: 0100 0110_b = 46_h (70°C)

Read/write command byte: 0010 0000_b = 20_h

Each LSB represents one degree centigrade. The values are in a two's complement binary format such that 0°C is reported as 0000 0000_b. See the [Temperature Data Format](#) section for more details.

Any writes to a temperature limit register will result in the corresponding fault queue being purged and reset.

5.16 Manufacturer ID Register (MFG_ID) 8-Bits, Read Only

TABLE 5-16: MANUFACTURER ID REGISTER INFORMATION

Manufacturer ID Register							
D[7] read-only	D[6] read-only	D[5] read-only	D[4] read-only	D[3] read-only	D[2] read-only	D[1] read-only	D[0] read-only
0	0	1	0	1	0	1	0
Bit		Function				Operation	
D[7:0]		Identifies Microchip as the manufacturer of the device				Read only. Always returns 2A _h	

Power-up default value: 0010 1010_b = 2A_h

Read command byte: 1111 1110_b = FE_h

5.17 Die Revision Register (DIE_REV) 8-Bits, Read Only

TABLE 5-17: DIE REVISION REGISTER INFORMATION

Die Revision Register							
D[7] read-only	D[6] read-only	D[5] read-only	D[4] read-only	D[3] read-only	D[2] read-only	D[1] read-only	D[0] read-only
MIC280 die revision number							
Bit		Function				Operation	
D[7:0]		Identifies the device revision number				Read only	

Power-up default value: [device revision number]_h

Read command byte: 1111 1111_b = FF_h

MIC280

6.0 APPLICATION INFORMATION

6.1 Remote Diode Section

Most small-signal PNP transistors with characteristics similar to the JEDEC 2N3906 will perform well as remote temperature sensors. Table 6-1 lists several examples of such parts that Microchip has tested for use with the MIC280. Other transistors equivalent to these should also work well.

TABLE 6-1: TRANSISTORS SUITABLE FOR USE AS REMOTE DIODES

Vendor	Part Number	Package
Fairchild Semiconductor	MMBT3906	SOT-23
On Semiconductor	MMBT3906L	SOT-23
Philips Semiconductor	PMBT3906	SOT-23
Samsung Semiconductor	KST3906-TF	SOT-23

6.2 Minimizing Errors

6.2.1 SELF-HEATING

One concern when using a part with the temperature accuracy and resolution of the MIC280 is to avoid errors induced by self-heating ($V_{DD} \times I_{DD}$) + ($V_{OL} \times I_{OL}$). In order to understand what level of error this might represent, and how to reduce that error, the dissipation in the MIC280 must be calculated and its effects reduced to a temperature offset. The worst-case operating condition for the MIC280 is when $V_{DD} = 3.6V$. The maximum power dissipated in the part is given in the following equations:

EQUATION 6-1:

$$P_D = [(I_{DD} \times V_{DD}) + (I_{OL(DATA)} \times V_{OL(DATA)}) + (I_{OL(INT)} \times V_{OL(INT)})]$$

EQUATION 6-2:

$$P_D = [(0.4mA \times 3.6V) + (6mA \times 0.5V) + (6mA \times 0.5V)] = 7.44mW$$

$R_{\theta(JA)}$ of the SOT23-6 package is $230^{\circ}C/W$. Theoretical Maximum ΔT_J due to self-heating is:

EQUATION 6-3:

$$7.44mW \times 230^{\circ}C/W = 1.7112^{\circ}C$$

In most applications, the /INT output will be low for at most a few milliseconds before the host resets it back to the high state, making its duty cycle low enough that its contribution to self-heating of the MIC280 is negligible. Similarly, the DATA pin will in all likelihood have a duty cycle of substantially below 25% in the low state. These considerations, combined with more typical device and application parameters, give a better system-level view of device self-heating in interrupt-mode usage given in the following equations:

EQUATION 6-4:

$$(0.23mA I_{DD(TYP)} \times 3.3V) + (0.25 \times 1.5mA I_{OL(DATA)} \times 0.15V) + (0.01 \times 1.5mA I_{OL(INT)} \times 0.15V) = 0.817mW$$

EQUATION 6-5:

$$\Delta T_J = (0.8175mW \times 230^{\circ}C/W) = 0.188^{\circ}C$$

In any application, the best test is to verify performance against calculation in the final application environment. This is especially true when dealing with systems for which temperature data may be poorly defined or unobtainable except by empirical means.

6.2.2 SERIES RESISTANCE

The operation of the MIC280 depends upon sensing the V_{CB-E} of a diode-connected PNP transistor (diode) at two different current levels. For remote temperature measurements, this is done using an external diode connected between T1 and ground. Because this technique relies upon measuring the relatively small voltage difference resulting from two levels of current through the external diode, any resistance in series with the external diode will cause an error in the temperature reading from the MIC280. A good rule of thumb is that for each ohm in series with the external transistor, there will be a $0.8^{\circ}C$ error in the MIC280's temperature measurement. It is not difficult to keep the series resistance well below an ohm (typically $<0.1\Omega$), so this will rarely be an issue.

6.3 Filter Capacitor Selection

It is usually desirable to employ a filter capacitor between the T1 and GND pins of the MIC280. The use of this capacitor is recommended in environments with a lot of high frequency noise (such as digital switching noise), or if long wires are used to connect to the remote diode. The maximum recommended total capacitance from the T1 pin to GND is 2200 pF. This typically suggests the use of a 1800 pF NP0 or C0G ceramic capacitor with a 10% tolerance. If the remote diode is to be at a distance of more than six-to-twelve inches from the MIC280, using twisted pair wiring or shielded microphone cable for the connections to the diode can significantly reduce noise pickup. If using a long run of shielded cable, remember to subtract the cable's conductor-to-shield capacitance from the 2200 pF maximum total capacitance.

6.4 Layout Considerations

The following guidelines should be kept in mind when designing and laying out circuits using the MIC280.

1. Place the MIC280 as close to the remote diode as possible, while taking care to avoid severe noise sources such as high frequency power transformers, CRTs, memory and data busses, and the like.
2. Because any conductance from the various voltages on the PC board and the T1 line can induce serious errors, it is good practice to guard the remote diode's emitter trace with a pair of ground traces. These ground traces should be returned to the MIC280's own ground pin. They should not be grounded at any other part of their run. However, it is highly desirable to use these guard traces to carry the diode's own ground return back to the ground pin of the MIC280, thereby providing a Kelvin connection for the base of the diode. See Figure 6-1.
3. When using the MIC280 to sense the temperature of a processor or other device which has an integral thermal diode, e.g., Intel's Pentium II, III, IV, AMD Athlon CPU, Xilinx Virtex FPGAs, connect the emitter and base of the remote sensor to the MIC280 using the guard traces and Kelvin return shown in Figure 6-1. The collector of the remote diode is typically inaccessible to the user on these devices. To allow for this, the MIC280 has superb rejection of noise appearing from collector to GND.
4. Due to the small currents involved in the measurement of the remote diode's ΔV_{BE} , it is important to adequately clean the PC board after soldering to prevent current leakage. This is most likely to show up as an issue in situations where water-soluble soldering fluxes are used.
5. In general, wider traces for the ground and T1 lines will help reduce susceptibility to radiated

noise (wider traces are less inductive). Use trace widths and spacing of 10 mm wherever possible and provide a ground plane under the MIC280 and under the connections from the MIC280 to the remote diode. This will help guard against stray noise pickup.

6. Always place a good quality power supply bypass capacitor directly adjacent to, or underneath, the MIC280. This should be a 0.1 μF ceramic capacitor. Surface-mount parts provide the best bypassing because of their low inductance.
7. When the MIC280 is being powered from particularly noisy power supplies, or from supplies which may have sudden high-amplitude spikes appearing on them, it can be helpful to add additional power supply filtering. This should be implemented as a 100 Ω resistor in series with the part's V_{DD} pin, and a 4.7 μF , 6.3V electrolytic capacitor from V_{DD} to GND. See Figure 6-2.

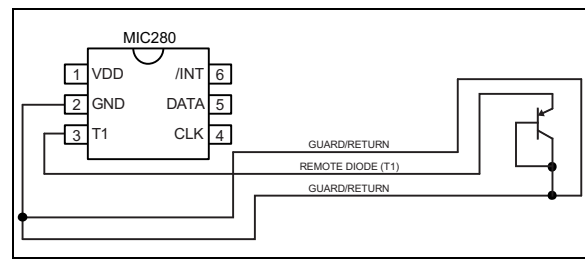

FIGURE 6-1: Guard Traces/Kelvin Ground Returns.

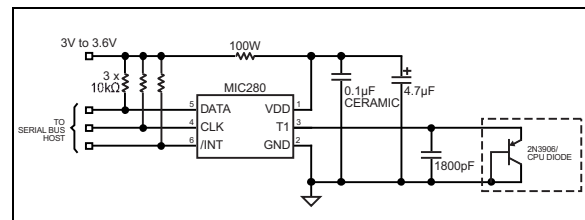

FIGURE 6-2: V_{DD} Decoupling for Very Noisy Supplies.

MIC280

7.0 PACKAGING INFORMATION

7.1 Package Marking Information

6-Pin SOT23*

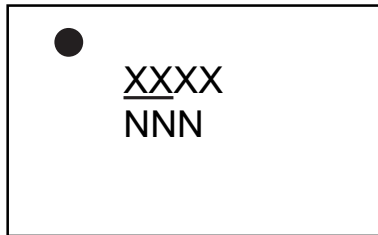

Example

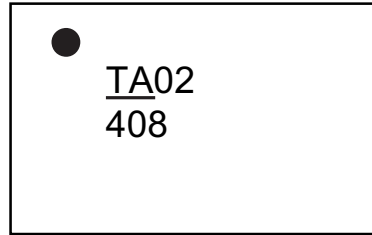

Legend:	XX...X	Product code or customer-specific information
	Y	Year code (last digit of calendar year)
	YY	Year code (last 2 digits of calendar year)
	WW	Week code (week of January 1 is week '01')
	NNN	Alphanumeric traceability code
	(e3)	Pb-free JEDEC® designator for Matte Tin (Sn)
	*	This package is Pb-free. The Pb-free JEDEC designator (e3) can be found on the outer packaging for this package.
	●, ▲, ▼	Pin one index is identified by a dot, delta up, or delta down (triangle mark).
Note:	In the event the full Microchip part number cannot be marked on one line, it will be carried over to the next line, thus limiting the number of available characters for customer-specific information. Package may or may not include the corporate logo. Underbar () and/or Overbar () symbol may not be to scale.	

6-Lead SOT-23 Package Outline and Recommended Land Pattern

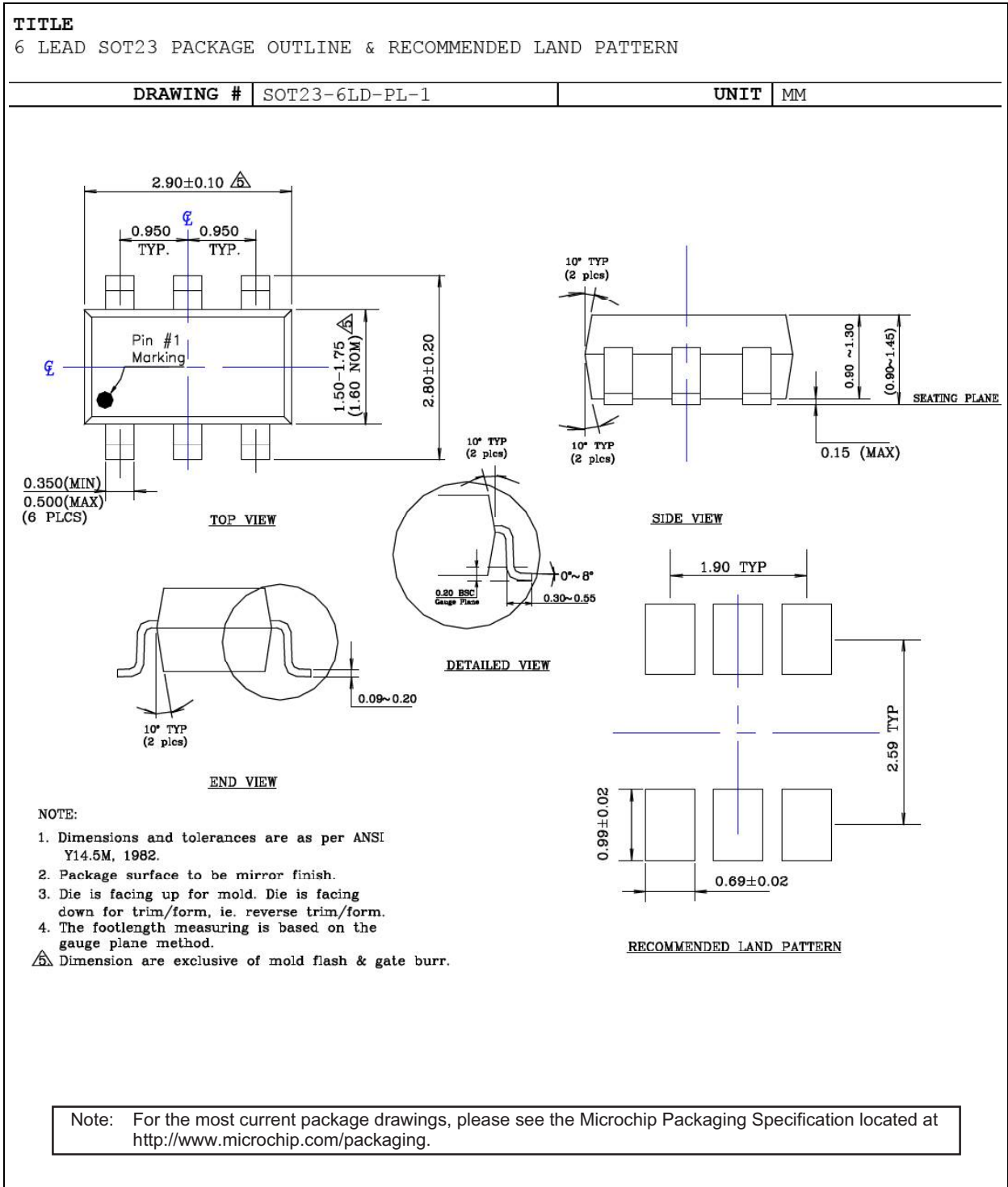

MIC280

NOTES:

APPENDIX A: REVISION HISTORY

Revision A (November 2020)

- Converted Micrel data sheet MIC280 to Microchip data sheet DS20006458A.
- Minor grammatical corrections throughout.

MIC280

NOTES:

PRODUCT IDENTIFICATION SYSTEM

To order or obtain information, e.g., on pricing or delivery, contact your local Microchip representative or sales office.

<u>PART NO.</u>	<u>-X</u>	<u>X</u>	<u>XX</u>	<u>-XX</u>	Examples:
Device	Client Address	Temperature Range	Package	Media Type	
Device:	MIC280:	Precision IttyBitty Thermal Supervisor			a) MIC280-0YM6-TR: Precision IttyBitty Thermal Supervisor, 100 1000 _b ClientAddress, -55°C to +125°C Temperature Range, SOT23-6 Package, 3,000/Reel
Client Address:	0 =	100 1000 _b			b) MIC280-0YM6-TX: Precision IttyBitty Thermal Supervisor, 100 1000 _b ClientAddress, -55°C to +125°C Temperature Range, SOT23-6 Package, 3,000/Reel (Reverse Tape & Reel)
	1 =	100 1001 _b			c) MIC280-1YM6-TR: Precision IttyBitty Thermal Supervisor, 100 1001 _b ClientAddress, -55°C to +125°C Temperature Range, SOT23-6 Package, 3,000/Reel
	2 =	100 1010 _b			d) MIC280-1YM6-TX: Precision IttyBitty Thermal Supervisor, 100 1001 _b ClientAddress, -55°C to +125°C Temperature Range, SOT23-6 Package, 3,000/Reel (Reverse Tape & Reel)
	3 =	100 1011 _b			e) MIC280-2YM6-TR: Precision IttyBitty Thermal Supervisor, 100 1010 _b ClientAddress, -55°C to +125°C Temperature Range, SOT23-6 Package, 3,000/Reel
	4 =	100 1100 _b			f) MIC280-2YM6-TX: Precision IttyBitty Thermal Supervisor, 100 1010 _b ClientAddress, -55°C to +125°C Temperature Range, SOT23-6 Package, 3,000/Reel (Reverse Tape & Reel)
	5 =	100 1101 _b			g) MIC280-3YM6-TR: Precision IttyBitty Thermal Supervisor, 100 1011 _b ClientAddress, -55°C to +125°C Temperature Range, SOT23-6 Package, 3,000/Reel
	6 =	100 1110 _b			h) MIC280-3YM6-TX: Precision IttyBitty Thermal Supervisor, 100 1011 _b ClientAddress, -55°C to +125°C Temperature Range, SOT23-6 Package, 3,000/Reel (Reverse Tape & Reel)
	7 =	100 1111 _b			i) MIC280-4YM6-TR: Precision IttyBitty Thermal Supervisor, 100 1100 _b ClientAddress, -55°C to +125°C Temperature Range, SOT23-6 Package, 3,000/Reel
Temperature:	Y =	-55°C to +125°C			j) MIC280-4YM6-TX: Precision IttyBitty Thermal Supervisor, 100 1100 _b ClientAddress, -55°C to +125°C Temperature Range, SOT23-6 Package, 3,000/Reel (Reverse Tape & Reel)
Package:	M6 =	SOT23-6			k) MIC280-5YM6-TR: Precision IttyBitty Thermal Supervisor, 100 1101 _b ClientAddress, -55°C to +125°C Temperature Range, SOT23-6 Package, 3,000/Reel
Media Type	TX =	3,000/Reel (Reverse Tape & Reel)			l) MIC280-5YM6-TX: Precision IttyBitty Thermal Supervisor, 100 1101 _b ClientAddress, -55°C to +125°C Temperature Range, SOT23-6 Package, 3,000/Reel (Reverse Tape & Reel)
	TR =	3,000/Reel			

MIC280

NOTES:

Note the following details of the code protection feature on Microchip devices:

- Microchip products meet the specifications contained in their particular Microchip Data Sheet.
- Microchip believes that its family of products is secure when used in the intended manner and under normal conditions.
- There are dishonest and possibly illegal methods being used in attempts to breach the code protection features of the Microchip devices. We believe that these methods require using the Microchip products in a manner outside the operating specifications contained in Microchip's Data Sheets. Attempts to breach these code protection features, most likely, cannot be accomplished without violating Microchip's intellectual property rights.
- Microchip is willing to work with any customer who is concerned about the integrity of its code.
- Neither Microchip nor any other semiconductor manufacturer can guarantee the security of its code. Code protection does not mean that we are guaranteeing the product is "unbreakable." Code protection is constantly evolving. We at Microchip are committed to continuously improving the code protection features of our products. Attempts to break Microchip's code protection feature may be a violation of the Digital Millennium Copyright Act. If such acts allow unauthorized access to your software or other copyrighted work, you may have a right to sue for relief under that Act.

Information contained in this publication is provided for the sole purpose of designing with and using Microchip products. Information regarding device applications and the like is provided only for your convenience and may be superseded by updates. It is your responsibility to ensure that your application meets with your specifications.

THIS INFORMATION IS PROVIDED BY MICROCHIP "AS IS". MICROCHIP MAKES NO REPRESENTATIONS OR WARRANTIES OF ANY KIND WHETHER EXPRESS OR IMPLIED, WRITTEN OR ORAL, STATUTORY OR OTHERWISE, RELATED TO THE INFORMATION INCLUDING BUT NOT LIMITED TO ANY IMPLIED WARRANTIES OF NON-INFRINGEMENT, MERCHANTABILITY, AND FITNESS FOR A PARTICULAR PURPOSE OR WARRANTIES RELATED TO ITS CONDITION, QUALITY, OR PERFORMANCE.

IN NO EVENT WILL MICROCHIP BE LIABLE FOR ANY INDIRECT, SPECIAL, PUNITIVE, INCIDENTAL OR CONSEQUENTIAL LOSS, DAMAGE, COST OR EXPENSE OF ANY KIND WHATSOEVER RELATED TO THE INFORMATION OR ITS USE, HOWEVER CAUSED, EVEN IF MICROCHIP HAS BEEN ADVISED OF THE POSSIBILITY OR THE DAMAGES ARE FORESEEABLE. TO THE FULLEST EXTENT ALLOWED BY LAW, MICROCHIP'S TOTAL LIABILITY ON ALL CLAIMS IN ANY WAY RELATED TO THE INFORMATION OR ITS USE WILL NOT EXCEED THE AMOUNT OF FEES, IF ANY, THAT YOU HAVE PAID DIRECTLY TO MICROCHIP FOR THE INFORMATION. Use of Microchip devices in life support and/or safety applications is entirely at the buyer's risk, and the buyer agrees to defend, indemnify and hold harmless Microchip from any and all damages, claims, suits, or expenses resulting from such use. No licenses are conveyed, implicitly or otherwise, under any Microchip intellectual property rights unless otherwise stated.

Trademarks

The Microchip name and logo, the Microchip logo, Adaptec, AnyRate, AVR, AVR logo, AVR Freaks, BesTime, BitCloud, chipKIT, chipKIT logo, CryptoMemory, CryptoRF, dsPIC, FlashFlex, flexPWR, HELDO, IGL00, JukeBlox, KeeLoq, Klear, LANCheck, LinkMD, maXStylus, maXTouch, MediaLB, megaAVR, Microsemi, Microsemi logo, MOST, MOST logo, MPLAB, OptoLyzer, PackeTime, PIC, picoPower, PICSTART, PIC32 logo, PolarFire, Prochip Designer, QTouch, SAM-BA, SenGenuity, SpyNIC, SST, SST Logo, SuperFlash, Symmetricom, SyncServer, Tachyon, TimeSource, tinyAVR, UNI/O, Vectron, and XMEGA are registered trademarks of Microchip Technology Incorporated in the U.S.A. and other countries.

AgileSwitch, APT, ClockWorks, The Embedded Control Solutions Company, EtherSynch, FlashTec, Hyper Speed Control, HyperLight Load, IntelliMOS, Libero, motorBench, mTouch, Powermite 3, Precision Edge, ProASIC, ProASIC Plus, ProASIC Plus logo, Quiet-Wire, SmartFusion, SyncWorld, Temux, TimeCesium, TimeHub, TimePictra, TimeProvider, WinPath, and ZL are registered trademarks of Microchip Technology Incorporated in the U.S.A.

Adjacent Key Suppression, AKS, Analog-for-the-Digital Age, Any Capacitor, AnyIn, AnyOut, Augmented Switching, BlueSky, BodyCom, CodeGuard, CryptoAuthentication, CryptoAutomotive, CryptoCompanion, CryptoController, dsPICDEM, dsPICDEM.net, Dynamic Average Matching, DAM, ECAN, Espresso T1S, EtherGREEN, IdealBridge, In-Circuit Serial Programming, ICSP, INICnet, Intelligent Paralleling, Inter-Chip Connectivity, JitterBlocker, maxCrypto, maxView, memBrain, Mindi, MiWi, MPASM, MPF, MPLAB Certified logo, MPLIB, MPLINK, MultiTRAK, NetDetach, Omniscient Code Generation, PICDEM, PICDEM.net, PICkit, PICtail, PowerSmart, PureSilicon, QMatrix, REAL ICE, Ripple Blocker, RTAX, RTG4, SAM-ICE, Serial Quad I/O, simpleMAP, SimpliPHY, SmartBuffer, SMART-I.S., storClad, SQI, SuperSwitcher, SuperSwitcher II, Switchtec, SynchroPHY, Total Endurance, TSHARC, USBCheck, VariSense, VectorBlox, VeriPHY, ViewSpan, WiperLock, XpressConnect, and ZENA are trademarks of Microchip Technology Incorporated in the U.S.A. and other countries.

SQTP is a service mark of Microchip Technology Incorporated in the U.S.A.

The Adaptec logo, Frequency on Demand, Silicon Storage Technology, and Symmcom are registered trademarks of Microchip Technology Inc. in other countries.

GestIC is a registered trademark of Microchip Technology Germany II GmbH & Co. KG, a subsidiary of Microchip Technology Inc., in other countries.

All other trademarks mentioned herein are property of their respective companies.

© 2020, Microchip Technology Incorporated, All Rights Reserved.

ISBN: 978-1-5224-7146-2

For information regarding Microchip's Quality Management Systems, please visit www.microchip.com/quality.



MICROCHIP

Worldwide Sales and Service

AMERICAS

Corporate Office
2355 West Chandler Blvd.
Chandler, AZ 85224-6199
Tel: 480-792-7200
Fax: 480-792-7277
Technical Support:
<http://www.microchip.com/support>
Web Address:
www.microchip.com

Atlanta

Duluth, GA
Tel: 678-957-9614
Fax: 678-957-1455

Austin, TX

Tel: 512-257-3370

Boston

Westborough, MA
Tel: 774-760-0087
Fax: 774-760-0088

Chicago

Itasca, IL
Tel: 630-285-0071
Fax: 630-285-0075

Dallas

Addison, TX
Tel: 972-818-7423
Fax: 972-818-2924

Detroit

Novi, MI
Tel: 248-848-4000

Houston, TX

Tel: 281-894-5983

Indianapolis

Noblesville, IN
Tel: 317-773-8323
Fax: 317-773-5453
Tel: 317-536-2380

Los Angeles

Mission Viejo, CA
Tel: 949-462-9523
Fax: 949-462-9608
Tel: 951-273-7800

Raleigh, NC

Tel: 919-844-7510

New York, NY

Tel: 631-435-6000

San Jose, CA

Tel: 408-735-9110
Tel: 408-436-4270

Canada - Toronto

Tel: 905-695-1980
Fax: 905-695-2078

ASIA/PACIFIC

Australia - Sydney
Tel: 61-2-9868-6733

China - Beijing
Tel: 86-10-8569-7000

China - Chengdu
Tel: 86-28-8665-5511

China - Chongqing
Tel: 86-23-8980-9588

China - Dongguan
Tel: 86-769-8702-9880

China - Guangzhou
Tel: 86-20-8755-8029

China - Hangzhou
Tel: 86-571-8792-8115

China - Hong Kong SAR
Tel: 852-2943-5100

China - Nanjing
Tel: 86-25-8473-2460

China - Qingdao
Tel: 86-532-8502-7355

China - Shanghai
Tel: 86-21-3326-8000

China - Shenyang
Tel: 86-24-2334-2829

China - Shenzhen
Tel: 86-755-8864-2200

China - Suzhou
Tel: 86-186-6233-1526

China - Wuhan
Tel: 86-27-5980-5300

China - Xian
Tel: 86-29-8833-7252

China - Xiamen
Tel: 86-592-2388138

China - Zhuhai
Tel: 86-756-3210040

ASIA/PACIFIC

India - Bangalore
Tel: 91-80-3090-4444

India - New Delhi
Tel: 91-11-4160-8631

India - Pune
Tel: 91-20-4121-0141

Japan - Osaka
Tel: 81-6-6152-7160

Japan - Tokyo
Tel: 81-3-6880-3770

Korea - Daegu
Tel: 82-53-744-4301

Korea - Seoul
Tel: 82-2-554-7200

Malaysia - Kuala Lumpur
Tel: 60-3-7651-7906

Malaysia - Penang
Tel: 60-4-227-8870

Philippines - Manila
Tel: 63-2-634-9065

Singapore
Tel: 65-6334-8870

Taiwan - Hsin Chu
Tel: 886-3-577-8366

Taiwan - Kaohsiung
Tel: 886-7-213-7830

Taiwan - Taipei
Tel: 886-2-2508-8600

Thailand - Bangkok
Tel: 66-2-694-1351

Vietnam - Ho Chi Minh
Tel: 84-28-5448-2100

EUROPE

Austria - Wels
Tel: 43-7242-2244-39
Fax: 43-7242-2244-393

Denmark - Copenhagen
Tel: 45-4485-5910
Fax: 45-4485-2829

Finland - Espoo
Tel: 358-9-4520-820

France - Paris
Tel: 33-1-69-53-63-20
Fax: 33-1-69-30-90-79

Germany - Garching
Tel: 49-8931-9700

Germany - Haan
Tel: 49-2129-3766400

Germany - Heilbronn
Tel: 49-7131-72400

Germany - Karlsruhe
Tel: 49-721-625370

Germany - Munich
Tel: 49-89-627-144-0
Fax: 49-89-627-144-44

Germany - Rosenheim
Tel: 49-8031-354-560

Israel - Ra'anana
Tel: 972-9-744-7705

Italy - Milan
Tel: 39-0331-742611
Fax: 39-0331-466781

Italy - Padova
Tel: 39-049-7625286

Netherlands - Drunen
Tel: 31-416-690399
Fax: 31-416-690340

Norway - Trondheim
Tel: 47-7288-4388

Poland - Warsaw
Tel: 48-22-3325737

Romania - Bucharest
Tel: 40-21-407-87-50

Spain - Madrid
Tel: 34-91-708-08-90
Fax: 34-91-708-08-91

Sweden - Gothenberg
Tel: 46-31-704-60-40

Sweden - Stockholm
Tel: 46-8-5090-4654

UK - Wokingham
Tel: 44-118-921-5800
Fax: 44-118-921-5820